

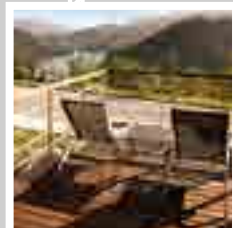

SIPHONS ABLÄUFE



Ø 300



HL Proizvodi

14. Hidroizolacione garniture
Ø 145 Nastavni elementi

14

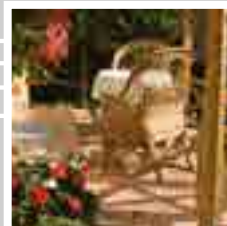

HL Hidroizolacione garniture – Proizvodi – Pregled

Dodatne podatke o hidroizolacionim garniturama možete pronaći u poglavlju podni slivnici, podoravni tuševi, balkoni/terase i građevinska hidroizolacija

Za modele slivnika	Vrsta hidroizolacionog materijala		
	Za alternativne hidroizolacije povezane sa keramičkim pločicama kao na primer epoksidni ili 2-komponentni-fleks- premazi	Za EPDM-trake, bitumenske pre-maze i za lepljenje sa bitumenskim kragnama	Za zavarivanje sa bitumenskim kragnama
HL83.M = HL70, HL80, HL90, HL92, HL300, HL304, HL310 i HL510 Nastavni element: HL85N	 HL83.M	 HL83	 HL83.H *
HL3100(T) i HL5100(T) Nastavni element: HL8500	 HL8300.M	 HL8300	 HL8300.H *
HL72.1 i HL317 Nastavni element: HL350.1	 HL84.M	 HL84	**
HL615 i HL616 Nastavni element: HL618	 HL86.M	 HL86	 HL86.H
Modeli krovnih slivnika HL62, HL63, HL64 i HL69 Nastavni element: HL65	 HL84.L	–	 HL84.H















* isto je i sa slivnikom na koji je fabrički spojena bitumenska hidroizolacija isporučivo kod serije slivnika HL80, HL615, HL616 kao i za seriju krovnih slivnika HL62, HL64, HL63, HL69 i nastavnih elemenata HL85, HL618, HL65

















** isporučivo sa fabrički spojenom hidroizolacijom!

*** stezno spajanje slivnika i krovne hidroizolacije sa INOX-prstenom

PVC-folije	FPO-folije odnosno TPO-folije	Za stežno spajanje sa elastičnim hidroizolacionim folijama	Za krovove pokrivenne bakarnim limom	Za krovove pokrivenne pocinkovanim limom
			-	-
HL83.P	HL83.PP	HL83.0		
			-	-
HL8300.P	HL8300.PP	HL8300.0		
***	***		-	-
		HL84.0		
***	***		-	-
		HL86.0		
**	**	**		
			HL84.CU	HL84.E

HL Nastavni elementi – Proizvodi – Pregled

Za modele slivnika	Za podešavanje visine prirubnice na nivo alternativne hidroizolacije	Za podešavanje visine prirubnice slivnika na nivo hidroizolacije	Za podešavanje visine prirubnice slivnika na nivo bitumenske hidroizolacije
HL70, HL80, HL90, HL300, HL304, HL310 i HL510	 <p>HL85N + HL83.M</p>	 <p>HL85N</p>	 <p>HL85NH</p>
HL3100 i HL5100	 <p>HL8500 + HL8300.M</p>	 <p>HL8500</p>	 <p>HL8500H</p>
HL72.1 i HL317	 <p>HL350.0</p>	 <p>HL350.0</p>	 <p>HL350.1H</p>
HL615 i HL616	 <p>HL618 + HL86.M</p>	 <p>HL618</p>	 <p>HL618H</p>
Modeli krovnih slivnika HL62 i HL64	-	 <p>HL65</p>	 <p>HL65H</p>
Balkonski i terasni slivnik HL92	-	-	-

Za podešavanje visine priрубnice slivnika na nivo PVC-hidroizolacije	Za podešavanje visine priрубnice slivnika na nivo FPO odnosno TPO-hidroizolacije	Za produžavanje završnog okvira
 <p>HL85N + HL83.P</p>	 <p>HL85N + HL83.PP</p>	 <p>HL340N</p>
 <p>HL8500 + HL8300.P</p>	 <p>HL8500 + HL8300.PP</p>	 <p>HL3400</p>
 <p>HL350.0</p>	 <p>HL350.0</p>	 <p>HL350</p>
 <p>HL618 + HL86.0</p>	 <p>HL618 + HL86.0</p>	 <p>HL620</p>
 <p>HL65P</p>	 <p>HL65F (HL65PE)</p>	 <p>HL350</p>
<p>-</p>	<p>-</p>	 <p>HL320</p>

HL Hidroizolacione garniture – Proizvodi – Podaci

HL83.0, HL8300.0, HL84.0, HL86.0 Garnitura bez folije

Podaci

Materijal	INOX V2A
Dimenzija	HL83.0: Ø 196 x 114 mm HL8300.0: Ø 238 x 148 mm HL84.0: Ø 220 x 155 mm HL86.0: Ø 278 x 198 mm
Preporučeno za	stezno spajanje krovne izolacije sa priрубnicom slivnika
Odgovara za	HL83.0: HL70, HL80, HL90, HL92, HL300, HL304, HL310 i HL510 slivnike kao i za nastavni element HL85N HL8300.0: HL3100(Pr) i HL5100(Pr) kao i za nastavni element HL8500 HL84.0: HL72.1 i HL317 HL86.0: HL615 i HL616 kao i za nastavni element HL618

HL83.0

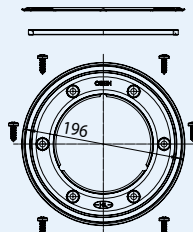

HL8300.0

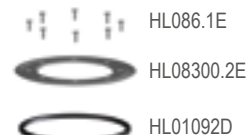
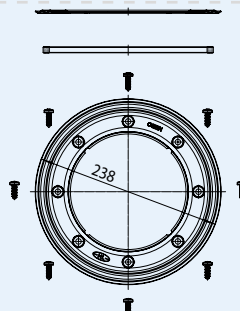

HL84.0

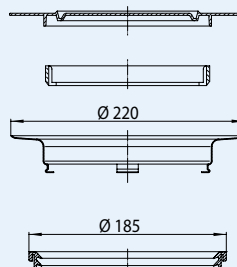

HL86.0

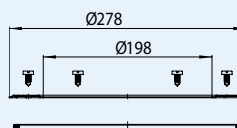

HL-br.	Težina	EAN	Kom./Pak.
83.0	245 g	+718306	1
8300.0	303 g	+025497	1
84.0	395 g	+718405	1
86.0	340 g	+711864	1

HL83.M, HL8300.M, HL84.M, HL86.M Dichtung garnitura sa diht-folijom lamirana vlaknom

Podaci

Materijal	INOX V2A/ diht-folija laminirana vlaknom
Dimenzija	HL83.M: Prirubnica Ø 196 x 114 mm, diht-folija lamirana vlaknom 400 x 500 mm HL8300.M: Prirubnica Ø 238 x 148 mm diht-folija lamirana vlaknom 500 x 500 mm HL84.M: Prirubnica Ø 220 x 155 mm diht-folija lamirana vlaknom 500 x 500 mm HL86.M: Prirubnica Ø 278 x 198 mm diht-folija lamirana vlaknom 500 x 500 mm
Preporučeno za	Za alternativne hidroizolacije povezane sa keramičkim pločicama kao na primer epoksidni, jedno- ili dvokomponentni-fleks- premazi
Odgovara za	HL83.M: HL70, HL80, HL90, HL92, HL300, HL304, HL310 i HL510 slivnike kao i za nastavni element HL85N HL8300.M: HL3100(Pr) und HL5100(Pr) kao i za nastavni element HL8500 HL84.M: HL72.1 und HL317 HL86.M: HL615 und HL616 kao i za nastavni element HL618

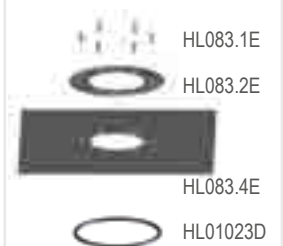
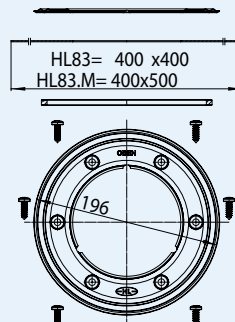
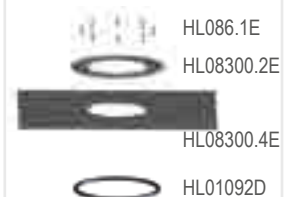
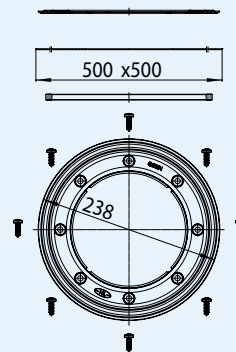
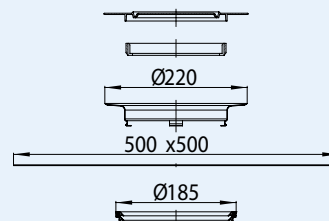
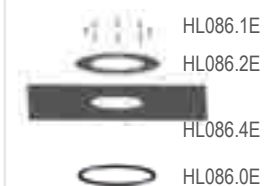
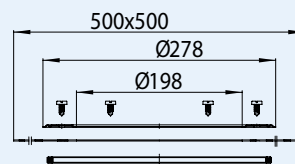
HL83.M

HL8300.M

HL84.M

HL86.M

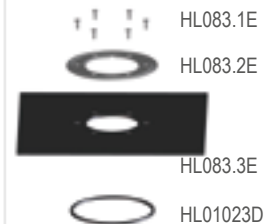
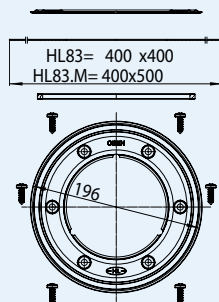
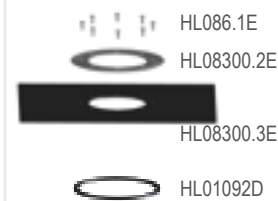
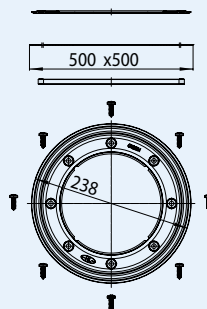
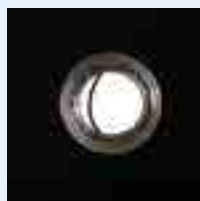
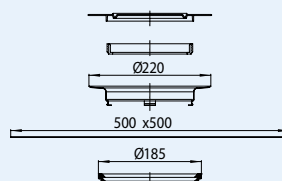
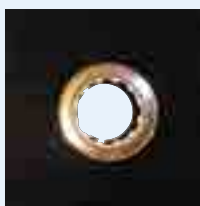
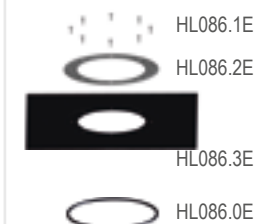
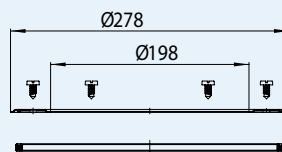
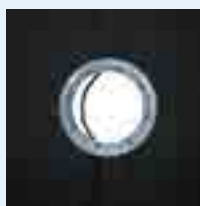
HL-br.	Težina	EAN	Kom./Pak.
83.M	425 g	+030835	1
8300.M	425 g	+025473	1
84.M	730 g	+030842	1
86.M	590 g	+713868	1

HL83, HL8300, HL84, HL86 Hidroizolaciona garnitura sa EPDM-folijom
Podaci

Materijal	INOX V2A/ EPDM-folija
Dimenzija	HL83: Prirubnica Ø 196 x 114 mm EPDM-folija 400 x 400 mm HL8300: Prirubnica Ø 238 x 148 mm EPDM-folija 500 x 500 mm HL84: Prirubnica Ø 220 x 155 mm EPDM-folija 500 x 500 mm HL86: Prirubnica Ø 278 x 198 mm EPDM-folija 500 x 500 mm
Preporučeno za	Za EPDM-trake, bitumenske premaze i za lepljenje sa bitumenskim kragnama
Odgovara za	HL83: HL70, HL80, HL90, HL92, HL300, HL304, HL310 i HL510 slivnike kao i za nastavni element HL85N HL8300: HL3100(Pr) i HL5100(Pr) kao i za nastavni element HL8500 HL84: HL72.1 i HL317 HL86: HL615 i HL616 kao i za nastavni element HL618

HL83

HL8300

HL84

HL86

HL-br.	Težina	EAN	Kom./Pak.
83	425 g	+710836	1
8300	601 g	+025466	1
84	730 g	+710843	1
86	590 g	+710867	1

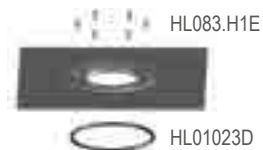
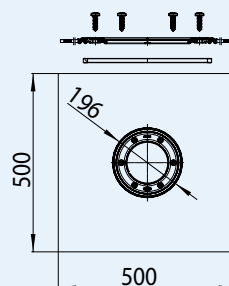
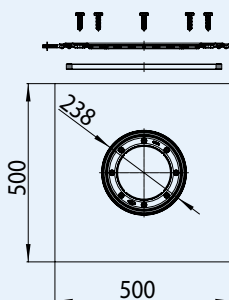
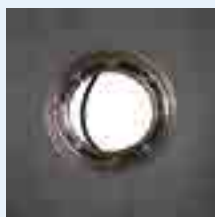
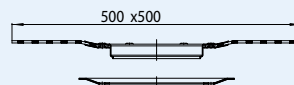
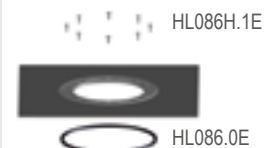
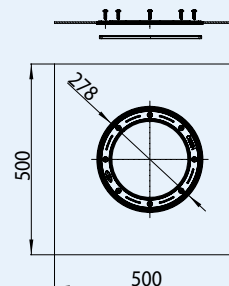
HL83.H, HL8300.H, HL84.H, HL86.H Hidroizolaciona garnitura sa bitumenskom kragom

Podaci

Materijal	INOX V2A/ Bitumen
Dimenzija	HL83.H: Priрубnica Ø 196 x 114 mm Bitumenska kragna 500 x 500 mm HL8300.H: Priрубnica Ø 238 x 148 mm Bitumenska kragna 500 x 500 mm HL84.H: Priрубnica Ø 220 x 155 mm Bitumenska kragna 500 x 500 mm HL86.H: Priрубnica Ø 278 x 198 mm Bitumenska kragna 500 x 500 mm
Preporučeno za	zavarivanje sa bitumenskim kragama
Odgovara za	HL83.H: HL70, HL80, HL90, HL92, HL300, HL304, HL310 i HL510 slivnike kao i za nastavni element HL85N HL8300.H: HL3100(Pr) i HL5100(Pr) kao i za nastavni element HL8500 HL84.H: Modeli krovnih slivnika: HL62, HL64, HL63, Nastavni element: HL65 HL86.H: HL615 i HL616 kao i za nastavni element HL618

HL83.H

HL8300.H

HL84.H

HL86.H

HL-br.	Težina	EAN	Kom./Pak.
83.H	1560 g	+008315	1
8300.H	1560 g	+025480	1
84.H	1707 g	+011841	1
86.H	1590 g	+008612	1

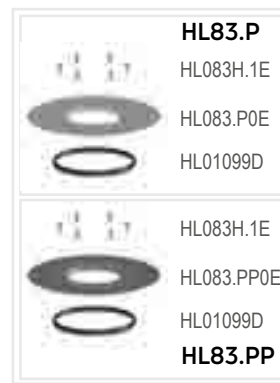
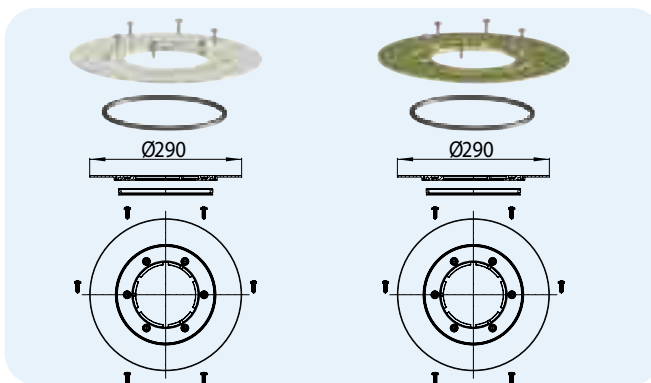
HL83.P, HL83.PP Hidroizolaciona garnitura sa PVC odnosno PP kragom

Podaci

Materijal	HL83.P: PVC HL83.PP: PP (Polipropilen)
Dimenzija	HL83.P: Prirubnica Ø 290 mm HL83.PP: Prirubnica Ø 290 mm
Preporučeno za	HL83.P: PVC-Hidroizolacije HL83.PP: FPO odnosno TPO Hidroizolacije na bazi PP (Polipropilen)
Odgovara za	HL70, HL80, HL90, HL92, HL300, HL304, HL310 i HL510 slivnike kao i za nastavni element HL85N



HL-br. 83.P	Težina 425 g	EAN +010837	Kom./Pak. 1
83.PP	653 g	+028641	1

HL8300.P, HL8300.PP Hidroizolaciona garnitura sa PVC odnosno PP kragom

Podaci

Materijal	HL8300.P: PVC HL8300.PP: PP
Dimenzija	HL8300.P: Prirubnica Ø 350 mm HL8300.PP: Prirubnica Ø 350 mm
Preporučeno za	HL8300.P: PVC-Hidroizolacije HL8300.PP: FPO odnosno TPO Hidroizolacije na bazi PP (Polipropilena)
Odgovara za	seriju slivnika HL3100 i HL5100 kao i za nastavni element HL8500

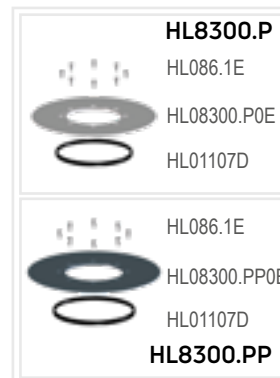
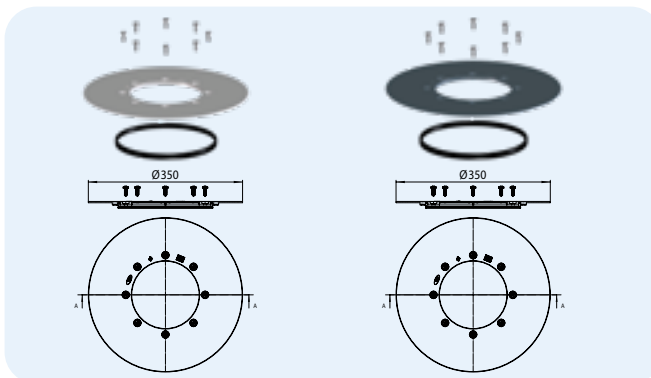

HL-br. 8300.P	Težina 530 g	EAN +034741	Kom./Pak. 1
8300.PP	320 g	+034758	1

HL84.CU, HL84.E Hidroizolaciona garnitura sa bakarnim odnosno pocinkovanim limom

Podaci

Materijal	HL84.CU: Bakarni lim HL84.E: Pocinkovani lim
Dimenzija	HL84.CU: 500 x 500 mm HL84.E: 500 x 500 mm
Preporučeno za	HL84.CU: za krovove pokrивene bakarnim limom HL84.E: za krovove pokrивene pocinkovanim limom
Odgovara za	Seriya krovnih slivnika HL62, HL63, HL64, HL65 i HL69

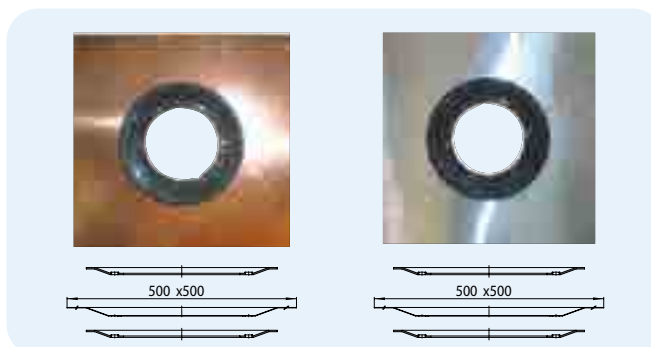

HL-br. 84.CU	Težina 1835 g	EAN +444847	Kom./Pak. 1
84.E	1830 g	+111848	1

HL84.L Hidroizolaciona garnitura sa folijom laminiranom vlaknima i TPE steznom površinom

Podaci

Materijal	TPE, folija laminirana vlaknima
Dimenzija	500 x 500 mm
Preporučeno za	Za tačne hidroizolacije bez rastvarača
Odgovara za	Krovne slivnike HL62, HL64 i HL65 sa steznom prirubnicom

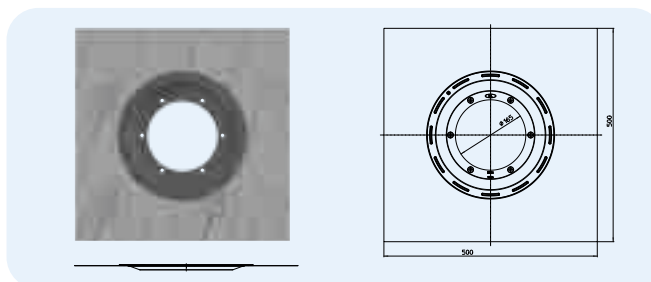

HL-br. 84.L	Težina 730 g	EAN +000739	Kom./Pak. 1
----------------	-----------------	----------------	----------------

HL Nastavni elementi – Proizvodi – Podaci

HL320, HL340N, HL3400, HL350, HL620 Nastavni element

Podaci

Materijal	PP (Polipropilen)
Dimenzija	HL320: Ø 90 mm, h: 35 mm HL340N: Ø 110 mm, h: 100 mm HL3400: Ø 146 mm, h: 200 mm HL350: Ø 145 mm, h: 130 mm HL620: Ø 195 mm, h: 100 mm
Preporučeno za	Za podešavanje visine završnog okvira
Odgovara za	HL320: HL92 HL340N: HL70, HL80, HL90, HL300, HL304, HL310 i HL510 slivnike kao i za nastavni element HL85N HL3400: seriju HL3100 i 5100 HL350: HL72.1, HL317, HL62, HL63, HL64, HL65, HL69 HL620: HL615 i HL616

HL320

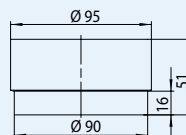

HL340N

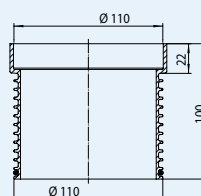

HL01067D

HL3400

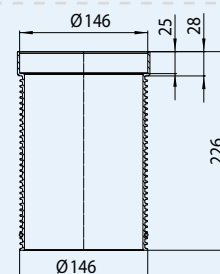

HL01093D

HL350

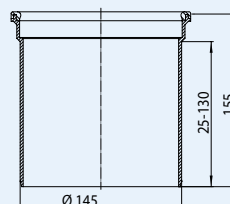

HL620

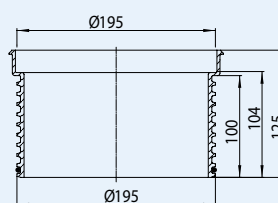

HL01056D

HL-br.	Težina	EAN	Kom./Pak.
340N	75 g	+003402	1
3400	117 g	+025565	1
350	240 g	+703500	1
620	270 g	+014255	1

HL85N, HL8500, HL350.1, HL350.0, HL618, HL65 Nastavni element sa prirubnicom

Podaci

Materijal	PP (Polipropilen)
Dimenzija	HL85N: Ø 110 x 220 mm, h: 204 mm HL8500: Ø 146 x 239 mm, h: 202 mm HL350.1: Ø 145 x 300 mm, h: 180 mm HL618: Ø 195 x 315 mm, h: 95 mm HL65: Ø 125 x 354 mm, h: 260 mm
Preporučeno za	Za podešavanje visine prirubnice slivnika na nivo hidroizolacije
Odgovara za	HL85N: HL70, HL80, HL90, HL92, HL300, HL304, HL310 i HL510 slivnike HL8500: HL3100(Pr) i HL5100(Pr) HL350.1: HL72.1, HL317, HL62, HL63, HL64, HL65 i HL69 HL618: HL615, HL616 HL65: HL62, HL64

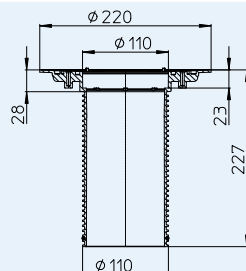
HL85N

HL01067D

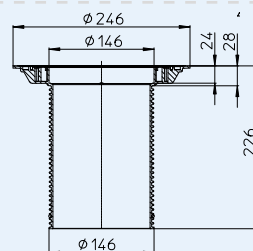
HL8500

HL03100.0E

HL01093D

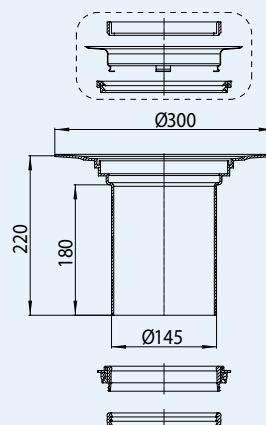
HL350.1 (HL350.0)

HL062B.3E

HL084.2E

HL084.3E

HL084.4E

HL01059D

HL01058D

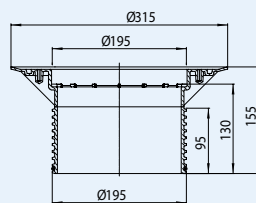
HL618

HL01056D

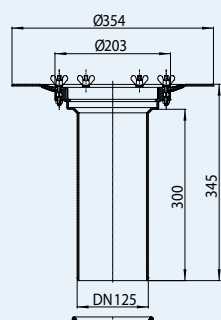
HL65

HL062.4E

HL170

HL062.3E

HL01020D

HL-br.	Težina	EAN	Kom./Pak.
85N	395 g	+006120	1
8500	320 g	+025572	1
350.0	680 g	+032358	1
350.1	1440 g	+703517	1
618	500 g	+013159	1
65	1440 g	+800650	1

HL85NH, HL8500H, HL350.1H, HL618H, HL65H Nastavni element sa fabrički povezanom bitumenskom kragnom

Podaci

Materijal	PP / INOX / Bitumen
Dimenzija	HL85NH: Ø 110 mm, h: 204 mm, Bitumenska kragna: Ø 420 mm HL8500H: Ø 146, h: 202 mm, Bitumenska kragna: 500 x 500 mm HL350.1H: Ø 145, h: 180 mm, Bitumenska kragna: Ø 500 mm HL618H: Ø 195 mm, h: 95 mm, Bitumenska kragna: 500 x 500 mm HL65H: Ø 125 mm, h: 260 mm, Bitumenska kragna: Ø 500 mm
Preporučeno za	Preporučeno za bitumenske kragne
Odgovara za	HL85NH: HL70, HL80, HL90, HL300, HL304, HL310 i HL510 slivnike HL350.1H: HL72.1, HL317, HL62, HL63, HL64, HL65, HL69 HL618H: HL615 und HL616 HL65H: HL62, HL64

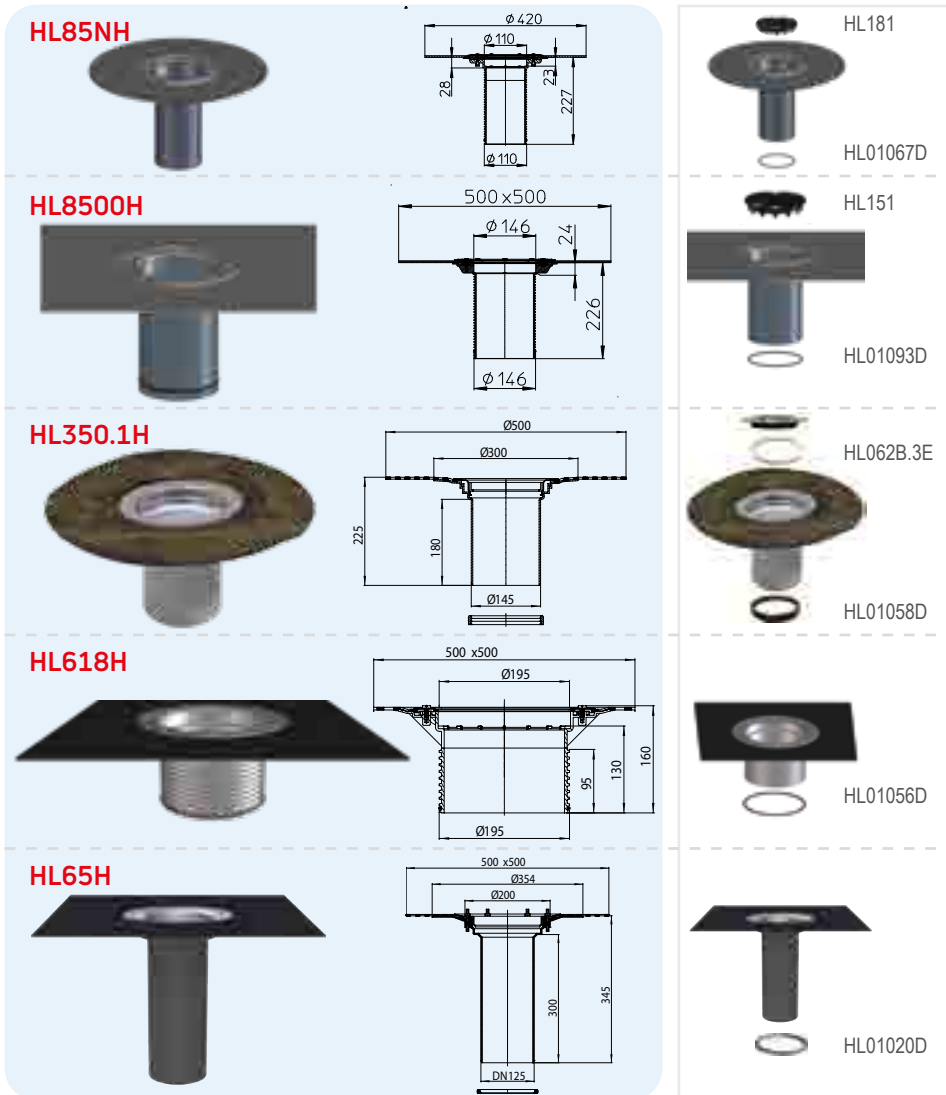

HL-br.	Težina	EAN	Kom./Pak.
85NH	980 g	+009015	1
8500H	2346 g	+034765	1
350.1H	1550 g	+001842	1
618H	1750 g	+013173	1
65H	2140 g	+801657	1

HL65P, HL65F, HL65PE Nastavni element

Podaci

Materijal	HL65P: PVC HL65F: PP (Polipropilen) HL65PE: PE (Polietilen)
Dimenzija	HL65P: Ø 125 mm, h: 350 mm, Prirubnica: Ø 354 mm HL65F, HL65PE: Ø 125 mm, h: 345 mm, Prirubnica: Ø 355 mm
Preporučeno za	HL65P: PVC-hidroizolacije HL65F: FPO odnosno TPO-hidroizolacije na bazi PP (Polipropilena) HL65PE: FPO-izolacije na bazi PE (Polietilena)
Odgovara za	seriju krovnih slivnika HL62 i HL64

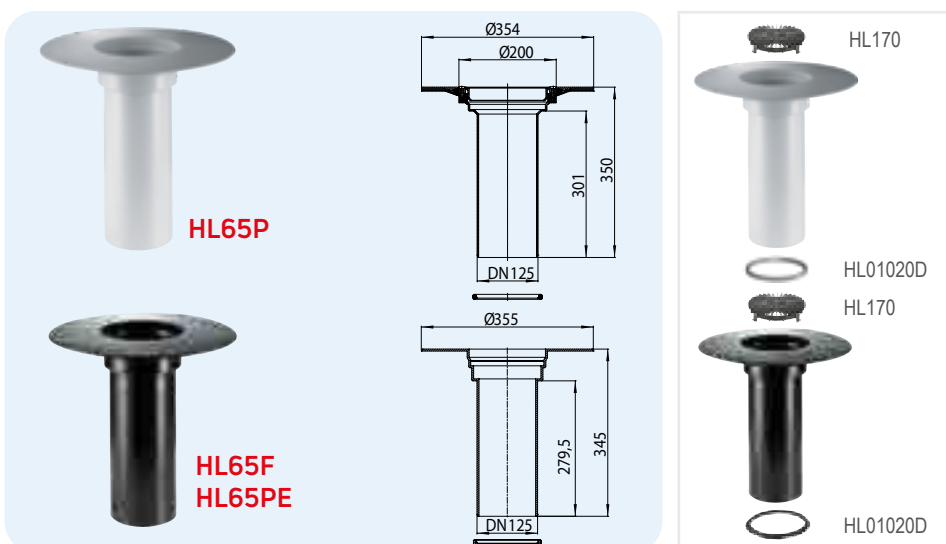

HL-br.	Težina	EAN	Kom./Pak.
65P	1370 g	+022588	1
65F	830 g	+031900	1



SIPHONS ABLÄUFE