

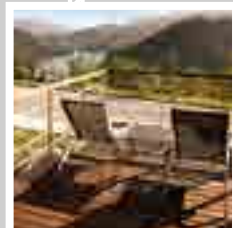

SIPHONS ABLÄUFE

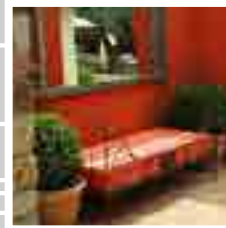

Ø 300



HL Tooted











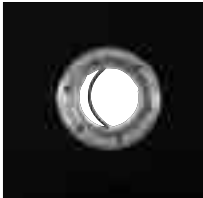

14. Tihenduskomplektid  
Ø 145 Pikendused

14



## HL Tihenduskomplektid - Tooted - Ülevaade





Enam andmeid jaotise „Tihenduskomplektid“ kohta vaadake pöranda äravoolude, piirdeta dušide, rõdu ja terrasside ning hüdroisolatsiooni peatükkidest.

Äravooludele	Hüdroisolatsiooni tüüp			
	2-komponendiga hüdroisolatsioon Nagu eksposüüd või elastne isolatsioon	EPDM-katetele, bituumenkatted, mida saab bituumenkatetega keevitada	Bituumenkatete keevitamine	
HL83.M = HL70, HL80, HL90, HL92, HL300, HL304, HL310-seeria, HL510-seeria  Pikendus: HL85N				
	<b>HL83.M</b>	<b>HL83</b>	<b>HL83.H *</b>	
HL3100(T) ir HL5100(T)  Pikendus: HL8500				
	<b>HL8300.M</b>	<b>HL8300</b>	<b>HL8300.H *</b>	
HL72.1 ir HL317  Pikendus: HL350.1				
	<b>HL84.M</b>	<b>HL84</b>	<b>**</b>	
HL615 ir HL616  Pikendus: HL618				
	<b>HL86.M</b>	<b>HL86</b>	<b>HL86.H</b>	
Katuse äravoolu tüübid HL62, HL63, HL64 ir HL69  Pikendus: HL65				
	<b>HL84.L</b>	<b>-</b>	<b>HL84.H</b>	















\* Saadaval ka bituumenäärrikuga äravoolu seeriatele HL80, HL615, HL616, katuse äravoolu seeriatele HL62, HL64, HL63, HL69 ja pikendustele HL85, HL618, HL65.

















\*\* Saadaval isolatsioonäärrikuga äravooluna!

\*\*\* Tihenduskomplekt on ühendatav (ilma katteta) kohapeal olevate katetega

PVC-membraanid	FPO-membraanid	Elastsete katete ühendamiseks	Vaskkattega katused	Tsinkkattega kastused
 <p>HL83.P</p>	 <p>HL83.PP</p>	 <p>HL83.0</p>	-	-
 <p>HL8300.P</p>	 <p>HL8300.PP</p>	 <p>HL8300.0</p>	-	-
***	***	 <p>HL84.0</p>	-	-
***	***	 <p>HL86.0</p>	-	-
**	**	**	 <p>HL84.CU</p>	 <p>HL84.E</p>

# HL Pikendused - Tooted - Ülevaade

Äravooludele	Kõrguse kohandamiseks; Ühendus 2- komponendiga hüdroisolatsiooniga	Kõrguse kohandamiseks äärikuga	Kõrguse kohandamiseks. Ühendus bituumenkatetega
HL70, HL80, HL90, HL300, HL304, HL310-seeria, HL510-seeria	 <p>HL85N + HL83.M</p>	 <p>HL85N</p>	 <p>HL85NH</p>
HL3100 ir HL5100	 <p>HL8500 + HL8300.M</p>	 <p>HL8500</p>	 <p>HL8500H</p>
HL72.1 ir HL317	 <p>HL350.0</p>	 <p>HL350.0</p>	 <p>HL350.1H</p>
HL615 ir HL616	 <p>HL618 + HL86.M</p>	 <p>HL618</p>	 <p>HL618H</p>
Katuse äravoolu tüübid HL62 ir HL64	-	 <p>HL65</p>	 <p>HL65H</p>
Rõdude ja terrasside äravoolud HL92	-	-	-

Kõrguse kohandamiseks. PVC-kattega ühendamiseks	Kõrguse kohandamiseks. FPO-kattega ühendamiseks	Pikenduse kõrguse suurendamiseks
 <p>HL85N + HL83.P</p>	 <p>HL85N + HL83.PP</p>	 <p>HL340N</p>
 <p>HL8500 + HL8300.P</p>	 <p>HL8500 + HL8300.PP</p>	 <p>HL3400</p>
 <p>HL350.0</p>	 <p>HL350.0</p>	 <p>HL350</p>
 <p>HL618 + HL86.0</p>	 <p>HL618 + HL86.0</p>	 <p>HL620</p>
 <p>HL65P</p>	 <p>HL65F (HL65PE)</p>	 <p>HL350</p>
<p>-</p>	<p>-</p>	 <p>HL320</p>

# HL Tihenduskomplektid - Tooted - Andmed

**HL83.0, HL8300.0, HL84.0, HL86.0** Komplektai mehaniniam hidroizolacijos tvirtinimui (be hidroizolacijos lakštų)

## Andmed

Materjal	Roostevaba teras V2A
Mõõdud	<b>HL83.0:</b> Ø 196 x 114 mm <b>HL8300.0:</b> Ø 238 x 148 mm <b>HL84.0:</b> Ø 220 x 155 mm <b>HL86.0:</b> Ø 278 x 198 mm
Soovitatud	Kohapealne katete ühendamine äärikuga
Sobib	<b>HL83.0:</b> HL70, HL80, HL90, HL92, HL300, HL304, HL310-series, HL510-seeria ja pikenduselement HL85N <b>HL8300.0:</b> HL3100(Pr) HL5100(Pr) Ja pikendus HL8500 <b>HL84.0:</b> HL72.1 ir HL317 <b>HL86.0:</b> HL615 ir HL616 Ja pikendus HL618

### HL83.0

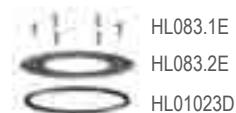
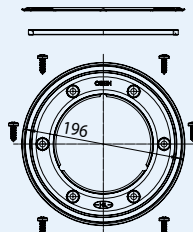

### HL8300.0

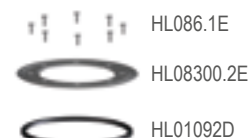
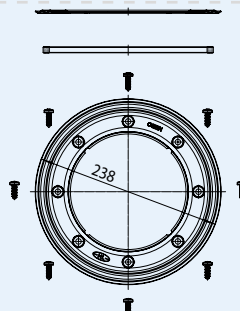

### HL84.0

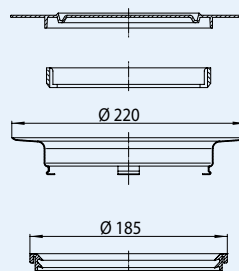

### HL86.0

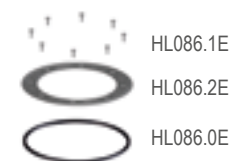
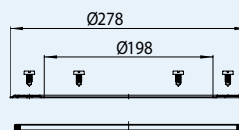

HL-Nr.	Kaal	EAN	Tk/pakend
83.0	245 g	+718306	1
8300.0	303 g	+025497	1
84.0	395 g	+718405	1
86.0	340 g	+711864	1

**HL83.M, HL8300.M, HL84.M, HL86.M** Tihenduskomplekt tekstiilkattega membraaniga

**Andmed**

Materjal	Roostevaba teras V2A / Tekstiilkattega membraaniga
Möödud	<b>HL83.M:</b> Äärik Ø 196 x 114 mm Tekstiilkattega membraan 400 x 500 mm <b>HL8300.M:</b> Äärik Ø 238 x 148 mm Tekstiilkattega membraan 500 x 500 mm <b>HL84.M:</b> Äärik Ø 220 x 155 mm Tekstiilkattega membraan 500 x 500 mm <b>HL86.M:</b> Äärik Ø 278 x 198 mm Tekstiilkattega membraan 500 x 500 mm
Soovitatud	<b>2- komponendiga hüdroisolatsioon nagu eksposüüd või elastne isolatsioon</b>
Sobib	<b>HL83.M:</b> HL70, HL80, HL90, HL92, HL300, HL304, HL310- seeria, HL510-seeria ja pikenduselement HL85N <b>HL8300.M:</b> HL3100(Pr) ja HL5100(Pr) ja Pikendus HL8500 <b>HL84.M:</b> HL72.1 ja HL317 <b>HL86.M:</b> HL615 ja HL616 ja Pikendus HL618

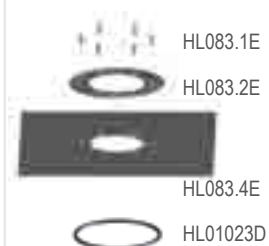
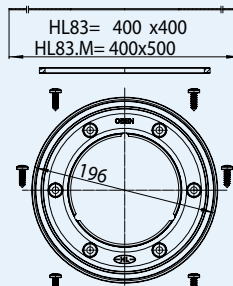
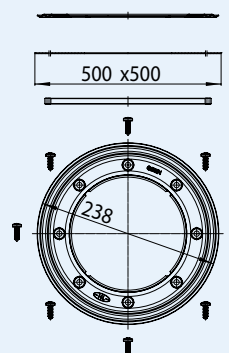
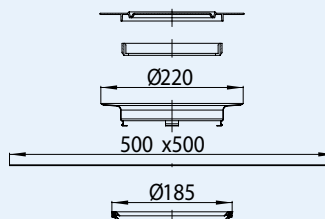
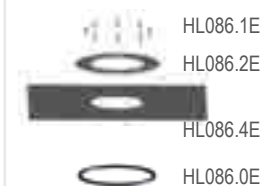
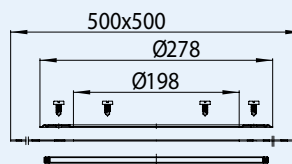
**HL83.M**

**HL8300.M**

**HL84.M**

**HL86.M**

HL-Nr.	Kaal	EAN	Tk/pakend
83.M	425 g	+030835	1
8300.M	425 g	+025473	1
84.M	730 g	+030842	1
86.M	590 g	+713868	1

## HL83, HL8300, HL84, HL86 Tihenduskomplekt EPDM-lehega

### Andmed

Materjal	Roostevabast terasest V2A/ EPDM
Mõõdud	<b>HL83:</b> Äärük Ø 196 x 114 mm EPDM-leht 400 x 400 m <b>HL8300:</b> Äärük Ø 238 x 148 mm EPDM-leht 500 x 500 mm <b>HL84:</b> Äärük Ø 220 x 155 mm EPDM-leht 500 x 500 mm <b>HL86:</b> Äärük Ø 278 x 198 mm EPDM-leht 500 x 500 mm
Soovitatud	<b>EPDM-katted, bituumen- Katted, bituumendiga keevitatavad katetega</b>
Sobib	<b>HL83:</b> HL70, HL80, HL90, HL92, HL300, HL304, HL310-seeria, HL510-seeria ja oikenduselement HL85N <b>HL8300:</b> HL3100(Pr) ja HL5100(Pr) ja Pikendus HL8500 <b>HL84:</b> HL72.1 ja HL317 <b>HL86:</b> HL615 ja HL616 ja Pikendus HL618

### HL83

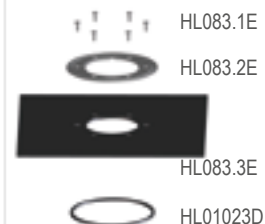
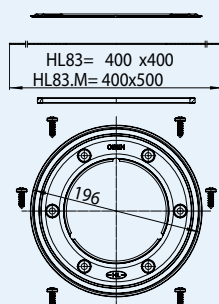

### HL8300

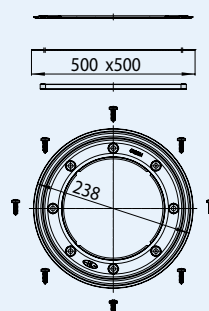
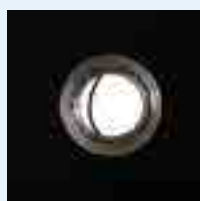

### HL84

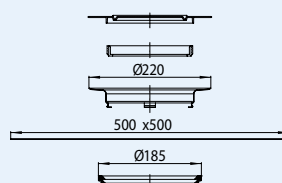
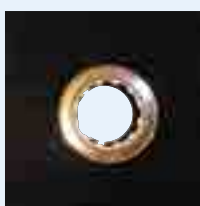

### HL86

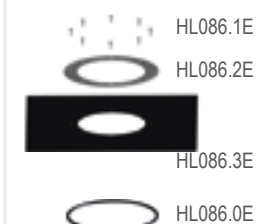
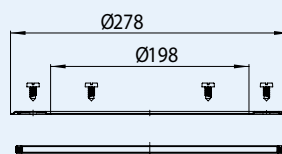
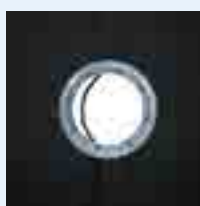

HL-Nr.	Kaal	EAN	Tk/pakend
83	425 g	+710836	1
8300	601 g	+025466	1
84	730 g	+710843	1
86	590 g	+710867	1

**HL83.H, HL8300.H, HL84.H, HL86.H** Tihenduskomplekt bituumenlehega

**Andmed**

Materjal	Roostevaba teras V2A/ bituumen
Möödud	<b>HL83.H:</b> Äärik Ø 196 x 114 mm bituumenkrae 500 x 500 mm <b>HL8300.H:</b> Äärik Ø 238 x 148 mm bituumenkrae 500 x 500 mm <b>HL84.H:</b> Äärik Ø 220 x 155 mm bituumenkrae 500 x 500 mm <b>HL86.H:</b> Äärik Ø 278 x 198 mm bituumenkrae 500 x 500 mm

**Soovitatud Bituumen hüdroisolatsiooni keevitamine**

Sobib	<b>HL83.H:</b> HL70, HL80, HL90, HL92, HL300, HL304, HL310-seeria, HL510-seeria ja pikenduselement HL85N <b>HL8300.H:</b> HL3100(Pr) ja HL5100(Pr) ja Pikendus HL8500 <b>HL84.H:</b> HL62, HL64, HL63 Pikendus: HL65 <b>HL86.H:</b> HL615 ja HL616 ja Pikendus HL618
-------	--

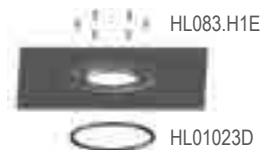
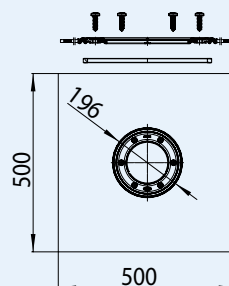
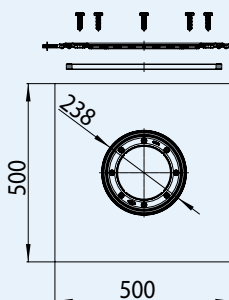
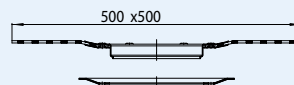
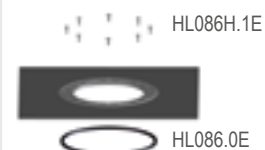
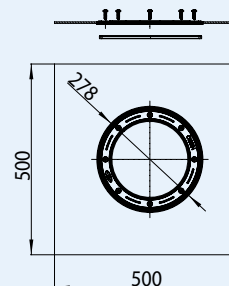
**HL83.H**

**HL8300.H**

**HL84.H**

**HL86.H**

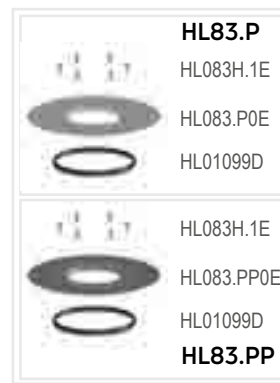
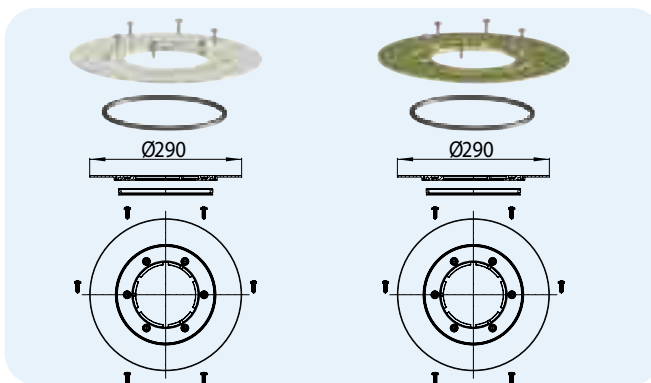
HL-Nr.	Kaal	EAN	Tk/pakend
83.H	1560 g	+008315	1
8300.H	1560 g	+025480	1
84.H	1707 g	+011841	1
86.H	1590 g	+008612	1

**HL83.P, HL83.PP Tihenduskomplekt PVC- või PP-äärikuga**
**Andmed**

Materjal	HL83.P: PVC HL83.PP: PP
Mõõdud	HL83.P: Äärik Ø 290 mm HL83.PP: Äärik Ø 290 mm
Soovitatud	HL83.P: PVC-katted HL83.PP: FPO-katted, PP põhised
Sobib	HL70, HL80, HL90, HL92, HL300, HL304, HL310-seeria, HL510-seeria ja pikenduselement HL85N



HL-Nr. 83.P 83.PP	Kaal 425 g 653 g	EAN +010837 +028641	Tk/pakend 1 1
-------------------------	------------------------	---------------------------	---------------------

**HL8300.P, HL8300.PP Tihenduskomplekt PVC- või PP-äärikuga**
**Andmed**

Materjal	HL8300.P: PVC HL8300.PP: PP
Mõõdud	HL8300.P: Äärik Ø 350 mm HL8300.PP: Äärik Ø 350 mm
Soovitatud	HL8300.P: PVC-hüdroisolatsioonid HL8300.PP: FPO-hüdroisolatsioonid PP-põhine
Sobib	Äravoolu seeriad HL3100 ja HL5100 pikendus HL8500

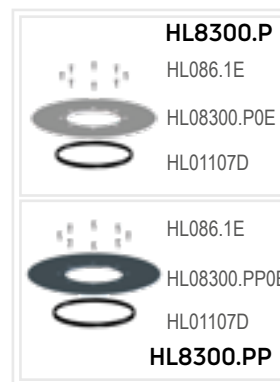
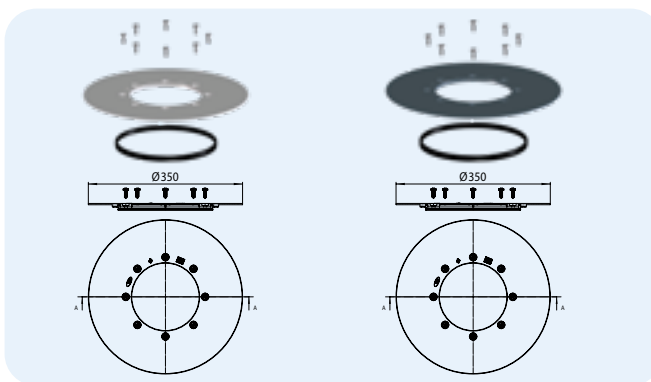

HL-Nr. 8300.P 8300.PP	Kaal 530 g 320 g	EAN +034741 +034758	Tk/pakend 1 1
-----------------------------	------------------------	---------------------------	---------------------

**HL84.CU, HL84.E Tihenduskomplekt vaskkraega või tsinkkattega kraega**
**Andmed**

Materjal	HL84.CU: Vask HL84.E: Vask
Mõõdud	HL84.CU: 500 x 500 mm HL84.E: 500 x 500 mm
Soovitatud	HL84.CU: Vaskkattega katused HL84.E: Tsingitud katusekatetega
Sobib	Katuse äravoolu seeriad HL62, HL63, HL64 HL65 ja HL69

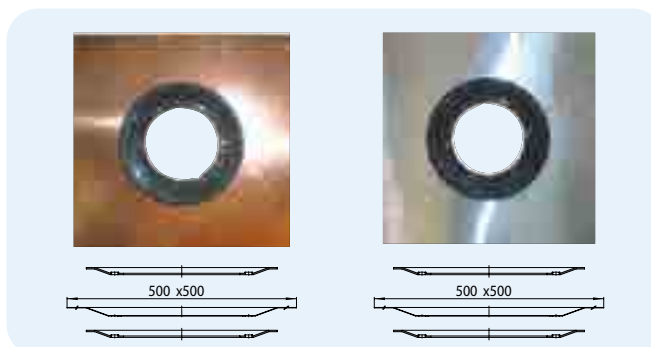

HL-Nr. 84.CU 84.E	Kaal 1835 g 1830 g	EAN +444847 +111848	Tk/pakend 1 1
-------------------------	--------------------------	---------------------------	---------------------

**HL84.L Lamineeritud tihendusäärik membraani ja TPE survetsooniga lahustivaba vedela veekindluse tagamiseks**
**Andmed**

Materjal	TPE, lamineeritud geotekstiil
Mõõdud	500 x 500 mm
Soovitatud	Lahustivabad veekindlad vedelikud
Sobib	HL62, HL64, HL69 roostevabast terasest kinnitusrõngaga

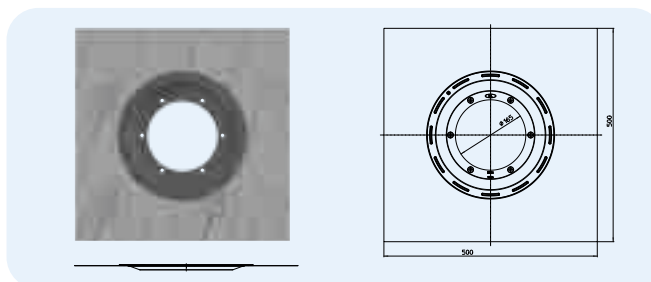

HL-Nr. 84.L	Kaal 730 g	EAN +000739	Tk/pakend 1
----------------	---------------	----------------	----------------

# HL Pikendused - Tooted - Andmed

## HL320, HL340N, HL3400, HL350, HL620 Pikendus

### Andmed

Materjal	PP
Mõõdud	<b>HL320:</b> Ø 90 mm, h: 35 mm <b>HL340N:</b> Ø 110 mm, h: 100 mm <b>HL3400:</b> Ø 146 mm, h: 200 mm <b>HL350:</b> Ø 145 mm, h: 130 mm <b>HL620:</b> Ø 195 mm, h: 100 mm
Soovitatud	Äravoolu kõrguse kohandamine
Sobib	<b>HL320:</b> HL92 <b>HL340N:</b> HL70, HL80, HL90, HL300, HL304, HL310-seeria, HL510-seeria ja pikenduselement HL85N <b>HL3400:</b> Seeriad HL3100(Pr0 ja HL5100(Pr) <b>HL350:</b> HL72.1, HL317, HL62, HL63, HL64, HL65, HL69 <b>HL620:</b> HL615 ja HL616

### HL320

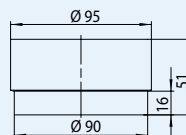

### HL340N

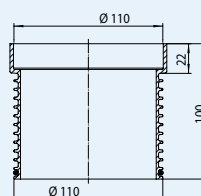

HL01067D

### HL3400

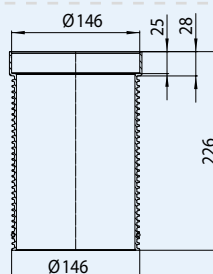

HL01093D

### HL350

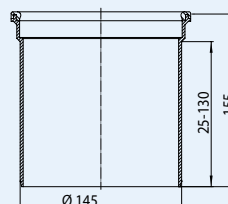

### HL620

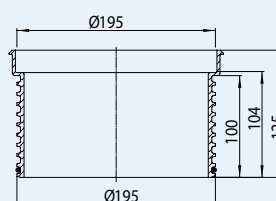

HL01056D

HL-Nr.	Kaal	EAN	Tk/pakend
340N	75 g	+003402	1
3400	117 g	+025565	1
350	240 g	+703500	1
620	270 g	+014255	1

**HL85N, HL8500, HL350.1, HL350.0, HL618, HL65** Pikendus äärikuga

**Andmed**

Materjal	PP
Möödud	<b>HL85N:</b> Ø 110 x 220 mm, h: 204 mm <b>HL8500:</b> Ø 146 x 239 mm, h: 202 mm <b>HL350.1 (HL350.0):</b> Ø 145 x 300 mm, h: 180 mm <b>HL618:</b> Ø 195 x 315 mm, h: 95 mm <b>HL65:</b> Ø 125 x 354 mm, h: 260 mm
Soovitatud	Äravoolu kõrguse kohandamine Hüdroisolatsiooni tasemega
Sobib	<b>HL85N:</b> HL70, HL80, HL90(Pr), HL300, HL304, HL310-seeria, HL510-seeria <b>HL8500:</b> HL3100(Pr) ja HL5100(Pr) <b>HL350.1 (HL350.0):</b> HL72.1, HL317, HL62, HL63, HL64, HL65 ja HL69 <b>HL618:</b> HL615, HL616 <b>HL65:</b> HL62, HL64

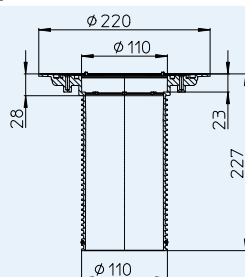
**HL85N**

HL01067D

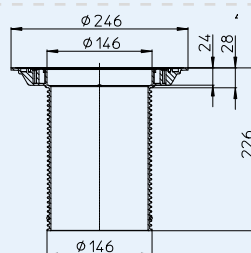
**HL8500**

HL03100.0E

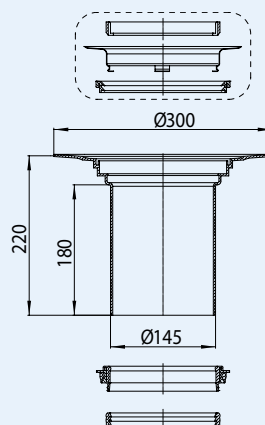

HL01093D

**HL350.1 (HL350.0)**

HL062B.3E



HL084.2E



HL084.3E



HL084.4E



HL01059D

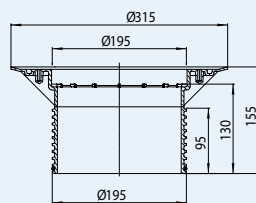

HL01058D

**HL618**

HL01056D

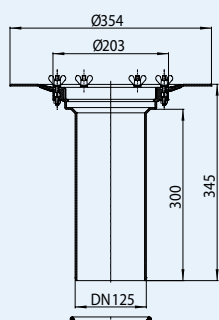
**HL65**

HL062.4E



HL170



HL062.3E



HL01020D

HL-Nr.	Kaal	EAN	Tk/pakend
85N	395 g	+006120	1
8500	320 g	+025572	1
350.0	680 g	+032358	1
350.1	1440 g	+703517	1
618	500 g	+013159	1
65	1440 g	+800650	1

**HL85NH, HL8500H, HL350.1H, HL618H, HL65H** Pikendus keevitatud bituumenäärikuga

**Andmed**

Materjal	PP/ roostevaba teras/ bituumen
Möödud	<b>HL85NH:</b> Ø 110 mm, h: 204 mm, Bituumenkrae: Ø 420 mm <b>HL8500H:</b> Ø 146, h: 202 mm, Bituumenkrae: 500 x 500 mm <b>HL350.1H:</b> Ø 145, h: 180 mm, Bituumenkrae: Ø 500 mm <b>HL618H:</b> Ø 195 mm, h: 95 mm, Bituumenkrae: 500 x 500 mm <b>HL65H:</b> Ø 125 mm, h: 260 mm, Bituumenkrae: Ø 500 mm
Soovitatud	Bituumen hüdroisolatsioonid
Sobib	<b>HL85NH:</b> HL70, HL80, HL90, HL300, HL304, HL310-seeria, HL510-seeria <b>HL350.1H:</b> HL72.1, HL317, HL62, HL63, HL64, HL65, HL69 <b>HL618H:</b> HL615 ir HL616 <b>HL65H:</b> HL62, HL64

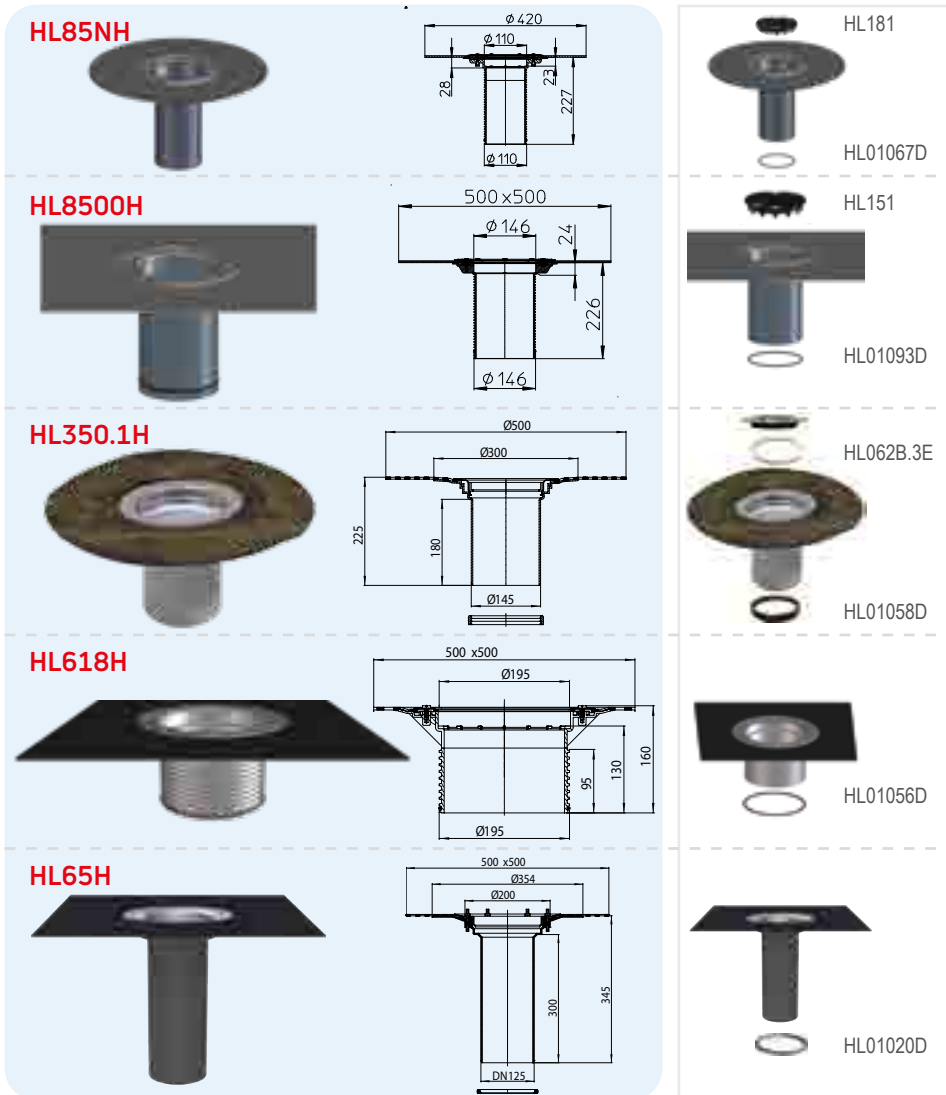

HL-Nr.	Kaal	EAN	Tk/pakend
85NH	980 g	+009015	1
8500H	2346 g	+034765	1
350.1H	1550 g	+001842	1
618H	1750 g	+013173	1
65H	2140 g	+801657	1

**HL65P, HL65F, HL65PE** Pikendus PVC- või PP-äärikuga

**Andmed**

Materjal	<b>HL65P:</b> PVC <b>HL65F:</b> PP <b>HL65PE:</b> PE
Möödud	<b>HL65P:</b> Ø 125 mm, h: 350 mm, Äärik: Ø 354 mm <b>HL65F, HL65PE:</b> Ø 125 mm, h: 345 mm, Äärik: Ø 355 mm
Soovitatud	<b>HL65P:</b> PVC-kattega katused <b>HL65F:</b> FPO-kattega katused PP-põhine <b>HL65PE:</b> FPO-kattega katused Pe-põhised
Sobib	Katuse äravoolud HL62 ja HL64

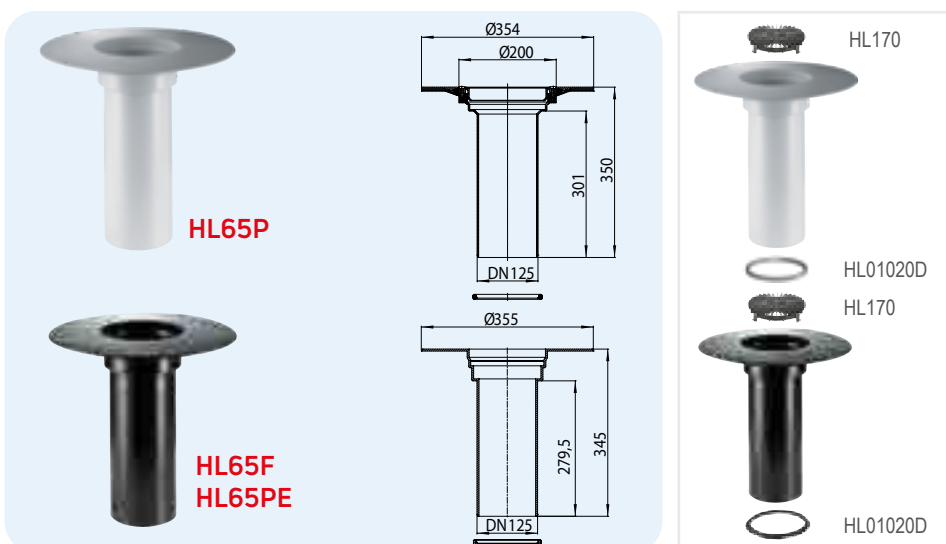

HL-Nr.	Kaal	EAN	Tk/pakend
65P	1370 g	+022588	1
65F	830 g	+031900	1
65PE	850 g	+035915	1



SIPHONS ABLÄUFE