

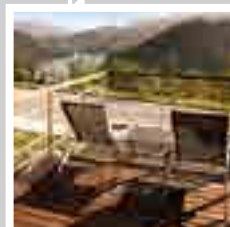

SIPHONS ABLÄUFE



Ø 300



HL Produkcija

14. Hidroizolācijas komplekti
Ø 145 Uzstādāmi elementi

14



HL Hidroizolācijas komplekti. Apskats.

Papildinformācija par hidroizolācijas elementiem sniegta nodaļās: „Trapi iekštelpām“, „Trapi dušām“, „Trapi balkoniem un terasēm“, kā arī „Būvju hidroizolācija“.

Trapi	Hidroizolācijas tipi		
	Keramisko segumu līmēšanai uz plānas mastikas slāņa vai divkomponenta epoksīda darvas pārklājumam.	EPDM membrānām, saskaņojamām ar polimēra līmējamo bitumena hidroizolāciju.	Sakausēšanai ar polimēro bitumena piekausējamo hidroizolāciju.
HL83.M = HL70, HL80, HL90, HL92, HL300, HL304, HL310 sērija, HL510 sērija Uzstādāms elements: HL85N	 <p style="text-align: center;">HL83.M</p>	 <p style="text-align: center;">HL83</p>	 <p style="text-align: center;">HL83.H *</p>
HL3100(T) un HL5100(T) Uzstādāms elements: HL8500	 <p style="text-align: center;">HL8300.M</p>	 <p style="text-align: center;">HL8300</p>	 <p style="text-align: center;">HL8300.H *</p>
HL72.1 un HL317 Uzstādāms elements: HL350.1	 <p style="text-align: center;">HL84.M</p>	 <p style="text-align: center;">HL84</p>	<p style="text-align: center;">**</p>
HL615 un HL616 Uzstādāms elements: HL618	 <p style="text-align: center;">HL86.M</p>	 <p style="text-align: center;">HL86</p>	 <p style="text-align: center;">HL86.H</p>
Jumta tehnēm sērija HL62, HL63, HL64 un HL69 Uzstādāms elements: HL65	 <p style="text-align: center;">HL84.L</p>	<p style="text-align: center;">-</p>	 <p style="text-align: center;">HL84.H</p>















* arī trapi ar korpusā iepresētu polimērā bitumena hidroizolācijas loksni – sērija HL80, HL615, HL616; jumta teknes sērija HL62, HL64, HL69 unuzstādāmie elementi HL85, HL618, HL65

















** trapi ar korpusā iepresētu polimērā bitumena hidroizolācijas loksni!

*** hidroizolācijas loksnes arī var būt piestiprinātas ar piespiešanas gredzena palīdzību.

PVC membrānas	FPO membrānas	Stiprināšanai ar polimērām hidroizolācijas membrānām	Lokšņu vara jumta segumi	Cinkotā lokšņu tērauda jumta segumi
 <p>HL83.P</p>	 <p>HL83.PP</p>	 <p>HL83.0</p>	-	-
 <p>HL8300.P</p>	 <p>HL8300.PP</p>	 <p>HL8300.0</p>	-	-
***	***	 <p>HL84.0</p>	-	-
***	***	 <p>HL86.0</p>	-	-
**	**	**	 <p>HL84.CU</p>	 <p>HL84.E</p>

HL Uzstādāmie elementi. Apskats.

Trapi	Uzstādāmie elementi divkomponentu epoksīda darvas pamatnes hidroizolācijai, smerējamai hidroizolācijai	Uzstādāmie elementi hidroizolācijas fiksēšanai ar atloku.	Uzstādāmie elementi polimērai bitumena hidroizolācijai (piekausējami)
H70, HL80, HL90, HL300, HL304, HL310-sērija, HL510 sērija	 <p data-bbox="517 689 724 719">HL85N + HL83.M</p>	 <p data-bbox="970 689 1054 719">HL85N</p>	 <p data-bbox="1283 689 1385 719">HL85NH</p>
HL3100 un HL5100	 <p data-bbox="491 983 746 1012">HL8500 + HL8300.M</p>	 <p data-bbox="963 983 1062 1012">HL8500</p>	 <p data-bbox="1273 983 1394 1012">HL8500H</p>
HL72.1 un HL317	 <p data-bbox="564 1236 671 1265">HL350.0</p>	 <p data-bbox="960 1236 1067 1265">HL350.0</p>	 <p data-bbox="1273 1236 1394 1265">HL350.1H</p>
HL615 un HL616	 <p data-bbox="517 1585 719 1615">HL618 + HL86.M</p>	 <p data-bbox="975 1585 1054 1615">HL618</p>	 <p data-bbox="1283 1585 1385 1615">HL618H</p>
Jumta tehnēm sērija HL62 un HL64	-	 <p data-bbox="979 1890 1050 1919">HL65</p>	 <p data-bbox="1289 1890 1375 1919">HL65H</p>
Trapi balkoniem un terasēm HL92	-	-	-

Uzstādāmie elementi PVC hidroizolācijas membrānām	Uzstādāmie elementi FPO hidroizolācijas membrānām	Uzstādāmo elementu paaugstināšanai
 <p>HL85N + HL83.P</p>	 <p>HL85N + HL83.PP</p>	 <p>HL340N</p>
 <p>HL8500 + HL8300.P</p>	 <p>HL8500 + HL8300.PP</p>	 <p>HL3400</p>
 <p>HL350.0</p>	 <p>HL350.0</p>	 <p>HL350</p>
 <p>HL618 + HL86.0</p>	 <p>HL618 + HL86.0</p>	 <p>HL620</p>
 <p>HL65P</p>	 <p>HL65F (HL65PE)</p>	 <p>HL350</p>
<p>-</p>	<p>-</p>	 <p>HL320</p>

HL Hidroizolācijas komplekti. Tehniskā informācija

HL83.0, HL8300.0, HL84.0, HL86.0 Komplektid hüdrolsatsiooni mehaaniliseks kinnitamiseks (ilma hüdrolsatsioonilehtedeta)

Informācija

Materiāls	Nerūsējošais tērauds V2A
Izmērs	HL83.0: Ø 196 x 114 mm HL8300.0: Ø 238 x 148 mm HL84.0: Ø 220 x 155 mm HL86.0: Ø 278 x 198 mm
Leteicams	Savienošanai ar hidroizolācijas lokšņu un trapa atloku Piemēroti
Piemērots	HL83.0: HL70, HL80, HL90, HL92, HL300, HL304, HL310-sērijai, HL510 sērijai un pagarinājuma elementam HL85N HL8300.0: HL3100(Pr) un HL5100(Pr) un Uzstādāms elements HL8500 HL84.0: HL72.1 un HL317 HL86.0: HL615 un HL616 un Uzstādāms elements HL618

HL83.0

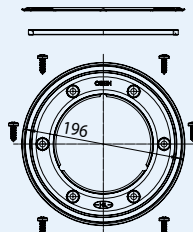

HL8300.0

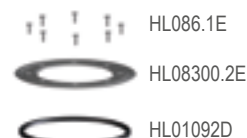
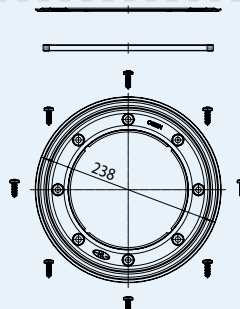

HL84.0

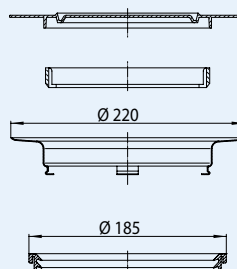

HL86.0

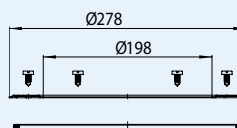

Artikuls	Svars	Svītrkods	Gab. iepak.
83.0	245 g	+718306	1
8300.0	303 g	+025497	1
84.0	395 g	+718405	1
86.0	340 g	+711864	1

HL83.M, HL8300.M, HL84.M, HL86.M Komplekti smērējamiem hidroizolācijas materiāliem
Informācija

Materiāls	Nerūsējošais tērauds V2A/ šķidriem uzsmērējamiem hidroizolācijas materiāliem
Izmērs	HL83.M: Atloks Ø 196 x 114 mm Šķidriem hidroizolācijas materiāliem 400 x 400 mm HL8300.M: Atloks Ø 238 x 148 mm Šķidriem hidroizolācijas materiāliem 500 x 500 mm HL84.M: Atloks Ø 220 x 155 mm Šķidriem hidroizolācijas materiāliem 500 x 500 mm HL86.M: Atloks Ø 278 x 198 mm Šķidriem hidroizolācijas materiāliem 500 x 500 mm
Leteicams	Keramisko segumu līmēšanai uz plāna mastikas slāņa vai divu komponentu epoksīda darvas iekļāšanai.
Piemēroti	HL83.M: HL70, HL80, HL90, HL92, HL300, HL304, HL310- sērija, HL510 sērijai un pagarinājuma elementam HL85N HL8300.M: HL3100(Pr) un HL5100(Pr) un Uzstādāms elements HL8500 HL84.M: HL72.1 un HL317 HL86.M: HL615 un HL616 un Uzstādāms elements HL618

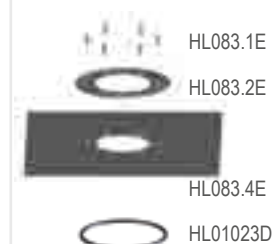
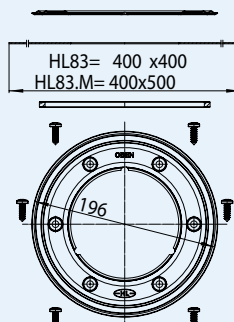
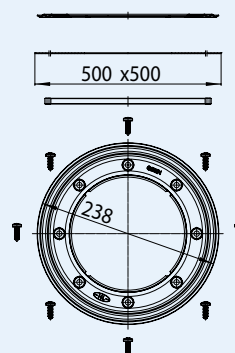
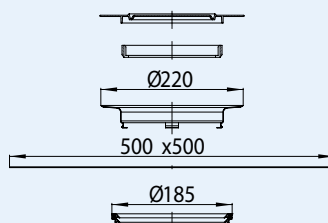
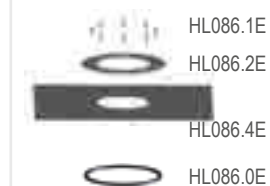
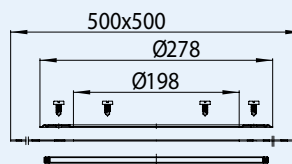
HL83.M

HL8300.M

HL84.M

HL86.M

Artikuls	Svars	Svītrkods	Gab. iepak.
83.M	425 g	+030835	1
8300.M	425 g	+025473	1
84.M	730 g	+030842	1
86.M	590 g	+713868	1

HL83, HL8300, HL84, HL86 Hidroizolācijas komplekti ar EPDM hidroizolācijas membrānām

Informācija

Materiāls	Nerūsējošais tērauds V2A/EPDM membrāna
Izmērs	HL83: Attoks Ø 196 x 114 mm EPDM loksne 400 x 400 mm HL8300: Attoks Ø 238 x 148 mm EPDM loksne 500 x 500 mm HL84: Attoks Ø 220 x 155 mm EPDM loksne 500 x 500 mm HL86: Attoks Ø 278 x 198 mm EPDM loksne 500 x 500 mm
Leteicams	Hidroizolācijas EPDM loksņēm, bitumena segumu līmēšanai ar bitumena loksni.
Piemēroti	HL83: HL70, HL80, HL90, HL92, HL300, HL304, HL310 sērijai, HL510-sērijai un pagarinājuma elementam HL85N HL8300: HL3100(Pr) un HL5100(Pr) kā arī Uzstādāms elements HL8500 HL84: HL72.1 un HL317 HL86: HL615 un HL616 un Uzstādāms elements HL618

HL83

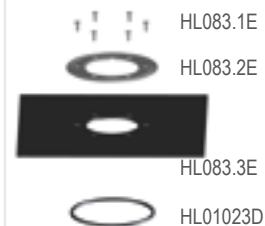
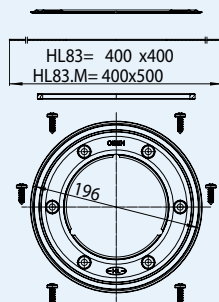

HL8300

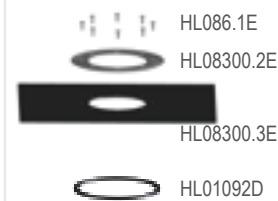
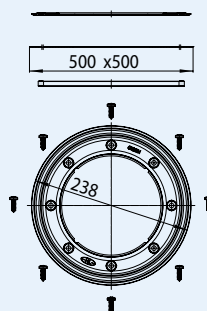
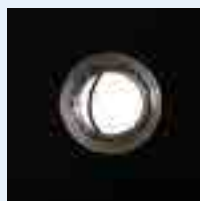

HL84

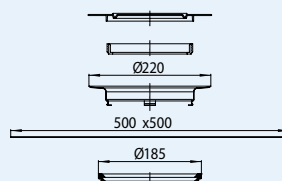
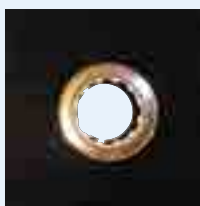

HL86

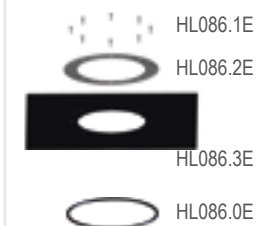
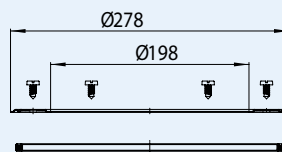
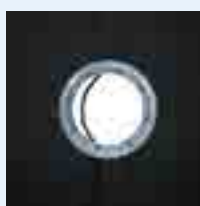

Artikuls	Svars	Svītrkods	Gab. iepak.
83	425 g	+710836	1
8300	601 g	+025466	1
84	730 g	+710843	1
86	590 g	+710867	1

HL83.H, HL8300.H, HL84.H, HL86.H Hidroizolācijas komplekti ar polimēra bitumena hidroizolācijas loksniem
Informācija

Materiāls	Nerūsējošais tērauds V2A/ polimēra bitumena loksne
Izmērs	HL83.H: Atloks Ø 196 x 114 mm Bitumena loksne 500 x 500 mm HL8300.H: Atloks Ø 238 x 148 mm Bitumena loksne 500 x 500 mm HL84.H: Atloks Ø 220 x 155 mm Bitumena loksne 500 x 500 mm HL86.H: Atloks Ø 278 x 198 mm Bitumena loksne 500 x 500 mm
Leteicams	Aplīmēšanai ar hidroizolācijas bitumena loksnes, pielīmēšanas ceļā
Piemēroti	HL83.H: HL70, HL80, HL90, HL92, HL300, HL304, HL310-sērija, arī HL510 sērija HL8300.H: HL3100(Pr) un HL5100(Pr) un Uzstādāms elements HL8500 HL84.H: HL62, HL64, HL63, Uzstādāms elements: HL65 HL86.H: HL615 und HL616 un Uzstādāms elements HL618

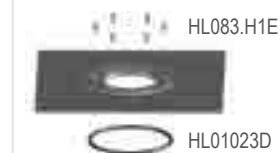
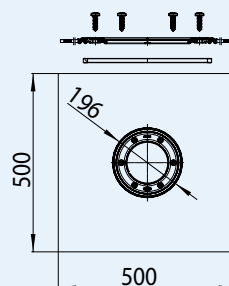
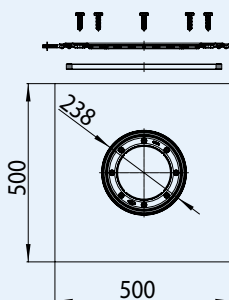
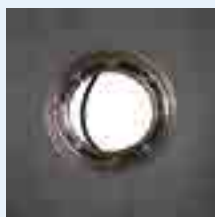
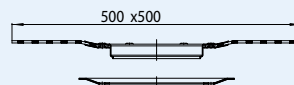
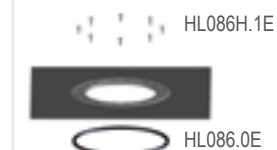
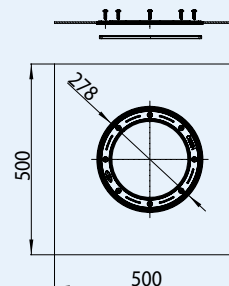
HL83.H

HL8300.H

HL84.H

HL86.H

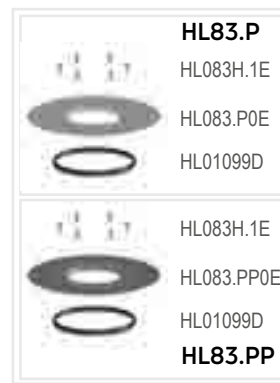
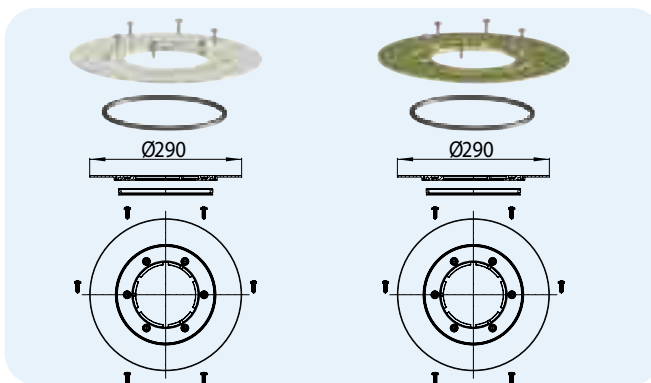
Artikuls	Svars	Svītrkods	Gab. iepak.
83.H	1560 g	+008315	1
8300.H	1560 g	+025480	1
84.H	1707 g	+011841	1
86.H	1590 g	+008612	1

HL83.P, HL83.PP Hidroizolācijas komplekti ar PVC vai PP atlokiem
Informācija

Materiāls	HL83.P: PVC HL83.PP: PP
Izmērs	HL83.P: Atloks Ø 290 mm HL83.PP: Atloks Ø 290 mm
Leteicams	HL83.P: polivinilhlorīda (PVC) hidroizolācijas loksne. HL83.PP: elastīga poliolefīna (FPO) loksne uz PP bāzes
Piemēroti	HL70, HL80, HL90, HL92, HL300, HL304, HL310, HL510-sērijai, arī pagarinājuma elementam HL85N



Artikuls 83.P 83.PP	Svars 425 g 653 g	Svītrkods +010837 +028641	Gab. iepak. 1 1
---------------------------	-------------------------	---------------------------------	-----------------------

HL8300.P, HL8300.PP Hidroizolācijas komplekti ar PVC vai PP atlokiem
Informācija

Materiāls	HL8300.P: PVC HL8300.PP: PP
Izmērs	HL8300.P: Atloks Ø 350 mm HL8300.PP: Atloks Ø 350 mm
Leteicams	HL8300.P: polivinilhlorīda (PVC) hidroizolācijas loksne. HL8300.PP: elastīga poliolefīna (FPO) loksne uz PP bāzes
Piemēroti	Trapu sērijai HL3100 ir HL5100, arī uzstādāmam elementam HL8500

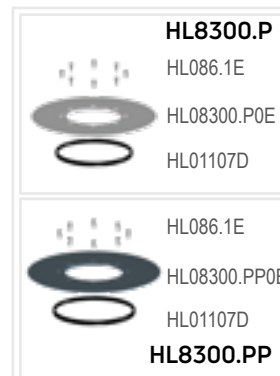
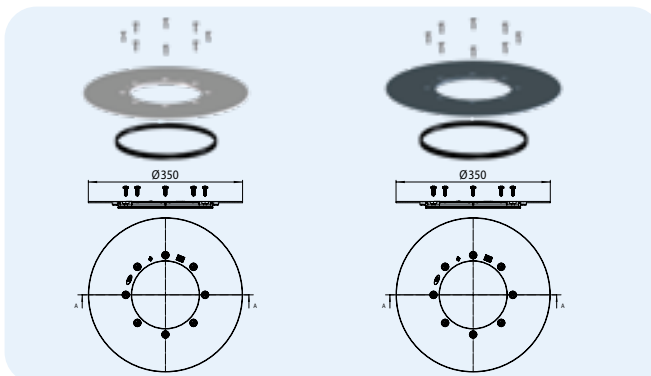

Artikuls 8300.P 8300.PP	Svars 530 g 320 g	Svītrkods +034741 +034758	Gab. iepak. 1 1
-------------------------------	-------------------------	---------------------------------	-----------------------

HL84.CU, HL84.E Hidroizolācijas komplekti ar vara vai cinkota tērauda loksņēm
Informācija

Materiāls	HL84.CU: vara loksne HL84.E: cinkotā tērauda loksne
Izmērs	HL84.CU: 500 x 500 mm HL84.E: 500 x 500 mm
Leteicams	HL84.CU: vara lokšņu jumta segums HL84.E: cinkotā tērauda lokšņu jumta segums
Piemēroti	Jumta tekņu modeļiem: Serie HL62, HL63, HL64, HL65 und HL69

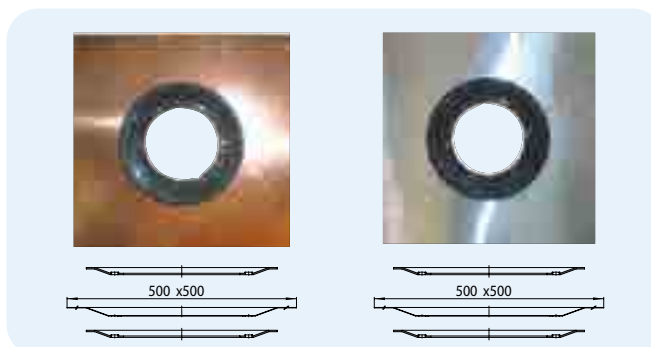

Artikuls 84.CU 84.E	Svars 1835 g 1830 g	Svītrkods +444847 +111848	Gab. iepak. 1 1
---------------------------	---------------------------	---------------------------------	-----------------------

HL84.L Laminēts blīvējuma atloks ar membrānu un TPE spiediena zonu šķidrāi hidroizolācijai bez šķīdinātājiem
Informācija

Materiāls	TPE, laminēts ģeotekstils
Izmērs	500 x 500 mm
Leteicams	Šķīdinātāju nesaturoši hidroizolācijas šķidrums
Piemēroti	HL62, HL64, HL69 ar nerūsējošā tērauda skavas gredzenu

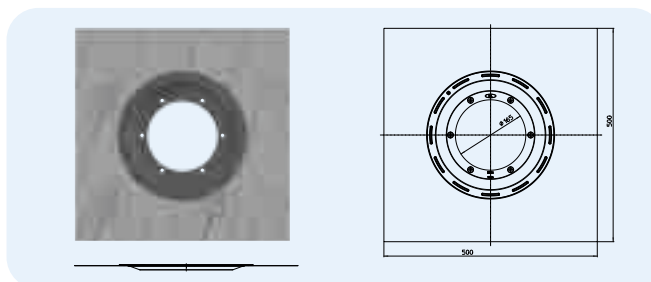

Artikuls 84.L	Svars 730 g	Svītrkods +000739	Gab. iepak. 1
------------------	----------------	----------------------	------------------

HL Uzstādāmie elementi. Tehniskā informācija

HL320, HL340N, HL3400, HL350, HL620 Paaugstinājums

Informācija

Materiāls	Polipropilēns (PP)
Izmērs	HL320: Ø 90 mm, h: 35 mm HL340N: Ø 110 mm, h: 100 mm HL3400: Ø 146 mm, h: 200 mm HL350: Ø 145 mm, h: 130 mm HL620: Ø 195 mm, h: 100 mm
Leteicams	Uzstādāmā elementa augstuma palielināšanai.
Piemēroti	HL320: HL92 HL340N: HL70, HL80, HL90, HL300, HL304, HL310 sērijai, HL510 sērijai un pagarinājuma elementam HL85N HL3400: Serie HL3100 un Serie HL5100 HL350: HL72.1, HL317, HL62, HL63, HL64, HL65, HL69 HL620: HL615 un HL616

HL320

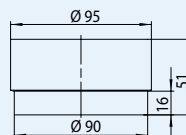

HL340N

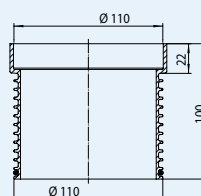

HL01067D

HL3400

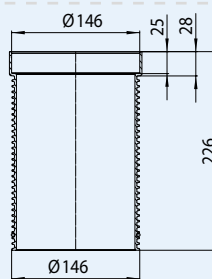

HL01093D

HL350

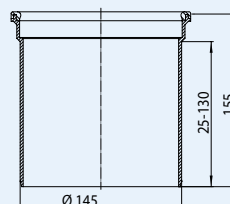

HL620

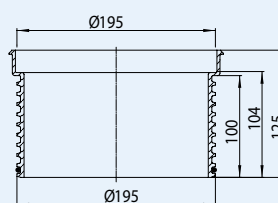

HL01056D

Artikuls	Svars	Svītrkods	Gab. iepak.
340N	75 g	+003402	1
3400	117 g	+025565	1
350	240 g	+703500	1
620	270 g	+014255	1

HL85N, HL8500, HL350.1, HL350.0, HL618, HL65 Uzstādāms elements ar atloku
Informācija

Materiāls	Polipropilēns (PP)
Lzmers	HL85N: Ø 110 x 220 mm, h: 204 mm HL8500: Ø 146 x 239 mm, h: 202 mm HL350.1 (HL350.0): Ø 145 x 300 mm, h: 180 mm HL618: Ø 195 x 315 mm, h: 95 mm HL65: Ø 125 x 354 mm, h: 260 mm
Leteicams	Mehāniskai hidroizolācijas stiprināšanai.
Piemēroti	HL85N: HL70, HL80, HL90(Pr), HL300, HL304, HL310 sērijai, HL510 sērijai HL8500: HL3100(Pr) un HL5100(Pr) HL350.1 (HL350.0): HL72.1, HL317, HL62, HL63, HL64, HL65 un HL69 HL618: HL615, HL616 HL65: HL62, HL64

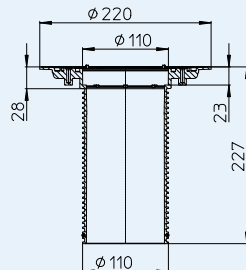
HL85N

HL01067D

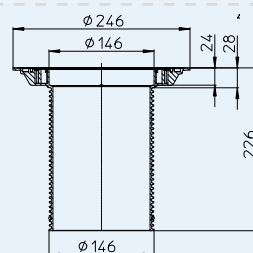
HL8500

HL03100.0E

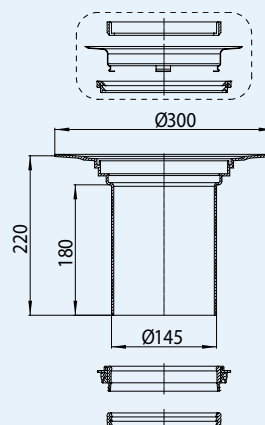

HL01093D

HL350.1 (HL350.0)

HL062B.3E



HL084.2E



HL084.3E



HL084.3E



HL084.4E



HL084.4E



HL01059D

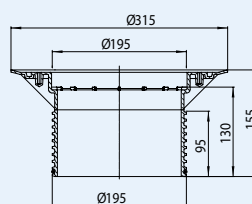

HL01058D

HL618

HL01056D

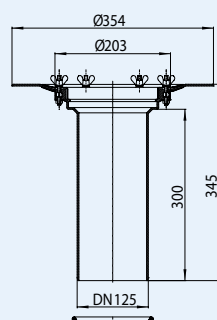
HL65

HL062.4E



HL170



HL062.3E



HL01020D



HL01020D



HL01020D



HL01020D



HL01020D

Artikuls	Svars	Svitrkods	Gab. iepak.
85N	395 g	+006120	1
8500	320 g	+025572	1
350.0	680 g	+032358	1
350.1	1440 g	+703517	1
618	500 g	+013159	1
65	1440 g	+800650	1

HL85NH, HL8500H, HL350.1H, HL618H, HL65H Uzstādāms elements ar hidroizolācijas polimēro bitumena loksni
Informācija

Materiāls	Polipropilēns (PP) / Nerūsējošais tērauds / polimēra bitumena loksne
Izmērs	HL85NH: Ø 110 mm, h: 204 mm, Bitumena loksne: Ø 420 mm HL8500H: Ø 146, h: 202 mm, Bitumena loksne: 500 x 500 mm HL350.1H: Ø 145, h: 180 mm, Bitumena loksne: Ø 500 mm HL618H: Ø 195 mm, h: 95 mm, Bitumena loksne: 500 x 500 mm HL65H: Ø 125 mm, h: 260 mm, Bitumena loksne: Ø 500 mm
Leteicams	Bitumena piekausējamai hidroizolācija
Piemēroti	HL85NH: HL70, HL80, HL90, HL300, HL304, HL310 sērija, HL510 sērija HL8500H: HL3100(Pr)(T), HL5100 (Pr)(T) HL350.1H: HL72.1, HL317, HL62, HL63, HL64, HL65, HL69 HL618H: HL615 und HL616 HL65H: HL62, HL64

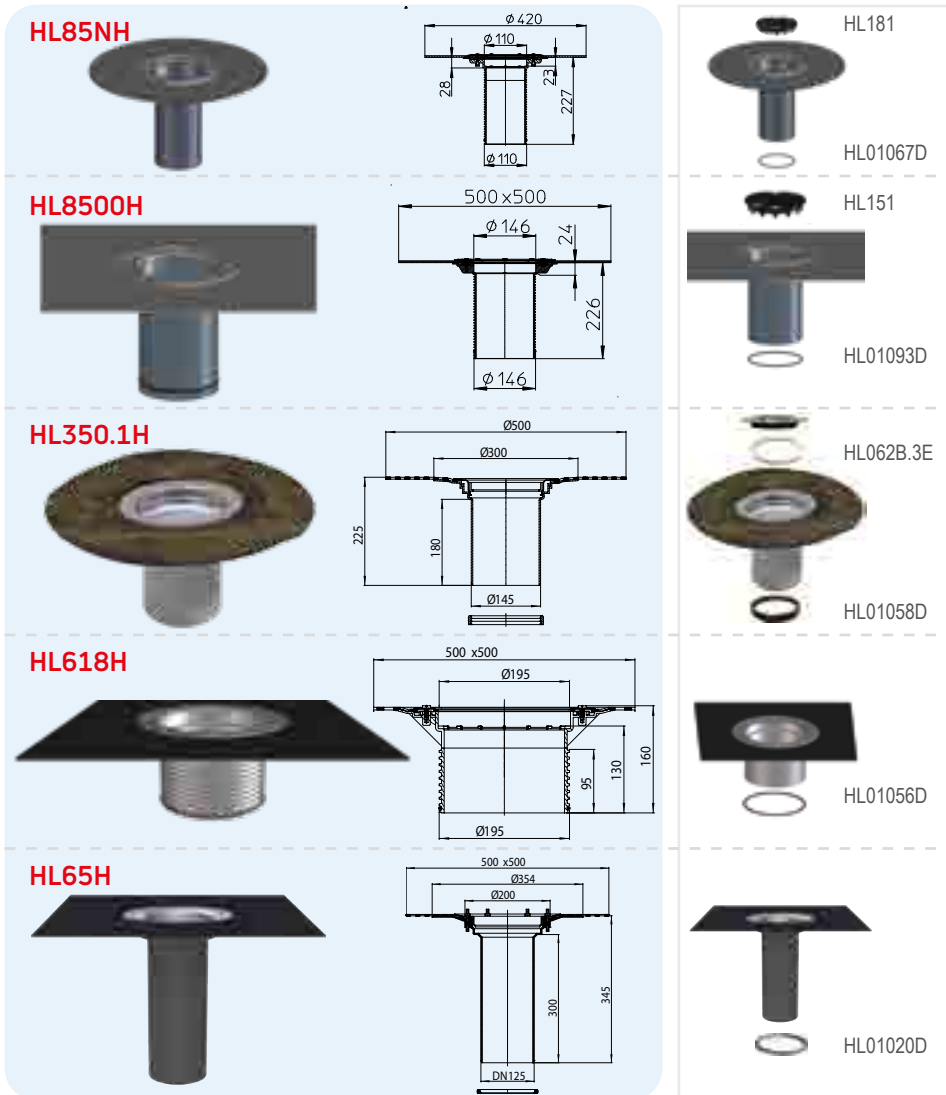

Artikuls	Svars	Svītrkods	Gab. iepak.
85NH	980 g	+009015	1
8500H	2346 g	+034765	1
350.1H	1550 g	+001842	1
618H	1750 g	+013173	1
65H	2140 g	+801657	1

HL65P, HL65F, HL65PE Uzstādāms elements
Informācija

Materiāls	HL65P: polivinilhlorīds (PVC) HL65F: Polipropilēns (PP) HL65PE: polietilēns (PE)
Izmērs	HL65P: Ø 125 mm, h: 350 mm, Atloks: Ø 354 mm HL65F, HL65PE: Ø 125 mm, h: 345 mm, Atloks: Ø 355 mm
Leteicams	HL65P: PVC hidroizolācijas membrāna HL65F: FPO hidroizolācijas membrāna (polipropilēna bāze) HL65PE: FPO hidroizolācijas membrāna (PE bāze)
Piemēroti	Jumta tehnēm sērija: HL62, HL64, HL69

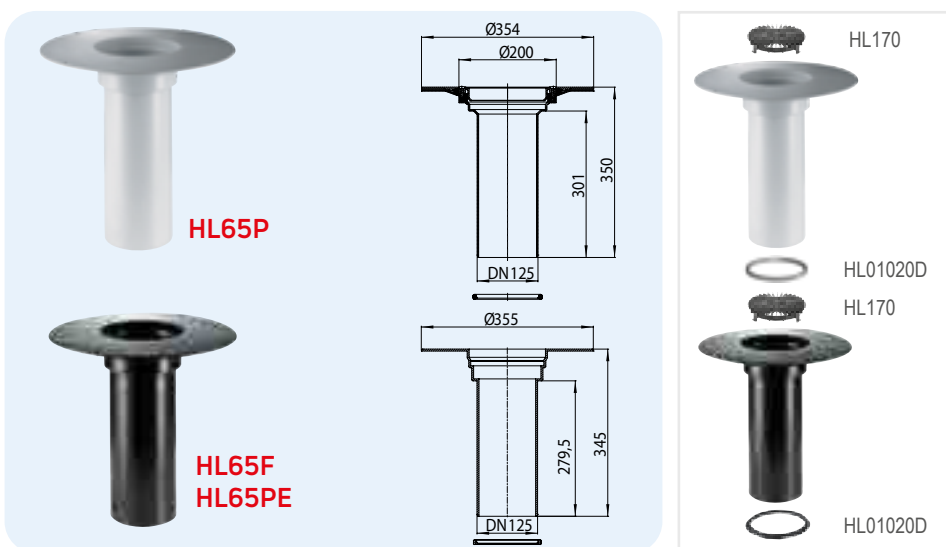

Artikuls	Svars	Svītrkods	Gab. iepak.
65P	1370 g	+022588	1
65F	830 g	+031900	1
65PE	850 g	+035915	1



SIPHONS ABLÄUFE