

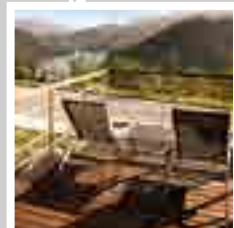

SIPHONS ABLÄUFE

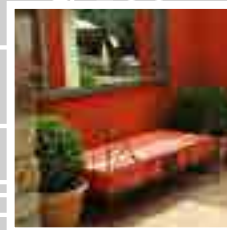

Ø 300



## HL Proizvodi

14. Hidroizolacijske garniture  
Ø 145      Nastavni elementi

# 14

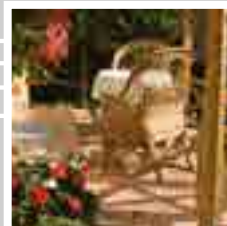

## HL Hidroizolacijske garniture – Proizvodi – Pregled

Više podataka na temu hidroizolacijskih garnitura možete naći u poglavlju podni slivnici, podoravni tuševi, balkoni/terase i građevinska hidroizolacija

Za modele slivnika	Vrsta hidroizolacijskog materijala		
	Za alternativne hidroizolacije povezane sa keramičnim pločicama kao na primjer epoksidni ili 2-komponentni-fleksi- premazi	Za EPDM-trake, bitumenske pre-maze i za ljepljenje sa bitumenskim trakama	Za zavarivanje sa bitumenskim trakama
HL70, HL80, HL90, HL92, HL300, HL304, HL310-serija, HL510-serija Nastavni element: HL85N	 HL83.M	 HL83	 HL83.H *
HL3100(T) i HL5100(T) Nastavni element: HL8500	 HL8300.M	 HL8300	 HL8300.H *
HL72.1 i HL317 Nastavni element: HL350.1	 HL84.M	 HL84	**
HL615 i HL616 Nastavni element: HL618	 HL86.M	 HL86	 HL86.H
Modeli krovnih slivnika HL62, HL63, HL64 i HL69 Nastavni element: HL65	 HL84.L	–	 HL84.H















\* isto sa tvornički integriranom bitumenskom hidroizolacijom, isporučivo kod serije slivnika HL80, HL615, HL616 kao i za seriju krovnih slivnika HL62, HL64, HL63, HL69. Nastavni elementi HL85, HL618, HL65

















\*\* isporučivo sa tvornički integriranom hidroizolacijom!

\*\*\* stezno spajanje krovne hidroizolacije sa slivnikom steznom garniturom

PVC-folije	FPO-folije odnosno TPO-folije	Za stezno spajanje sa elastičnim hidroizolacijskim folijama	Za krovove pokrivenne bakrenim limom	Za krovove pokrivenne pocinčanim limom
 <p>HL83.P</p>	 <p>HL83.PP</p>	 <p>HL83.0</p>	-	-
 <p>HL8300.P</p>	 <p>HL8300.PP</p>	 <p>HL8300.0</p>	-	-
***	***	 <p>HL84.0</p>	-	-
***	***	 <p>HL86.0</p>	-	-
**	**	**	 <p>HL84.CU</p>	 <p>HL84.E</p>

## HL Nastavni elementi – Proizvodi – Pregled

Za modele slivnika	Za podešavanje visine prirubnice na nivo alternativne hidroizolacije	Za podešavanje visine prirubnice slivnika na nivo hidroizolacije	Za podešavanje visine prirubnice slivnika na nivo bitumenske hidroizolacije
HL70, HL80, HL90, HL92, HL300, HL304, HL310-serija, HL510-serija	 <p>HL85N + HL83.M</p>	 <p>HL85N</p>	 <p>HL85NH</p>
HL3100 i HL5100	 <p>HL8500 + HL8300.M</p>	 <p>HL8500</p>	 <p>HL8500H</p>
HL72.1 i HL317	 <p>HL350.0</p>	 <p>HL350.0</p>	 <p>HL350.1H</p>
HL615 i HL616	 <p>HL618 + HL86.M</p>	 <p>HL618</p>	 <p>HL618H</p>
Modeli krovnih slivnika HL62 i HL64	-	 <p>HL65</p>	 <p>HL65H</p>
Balkonski i terasni slivnik HL92	-	-	-

Za podešavanje visine priрубnice slivnika na nivo PVC-hidroizolacije	Za podešavanje visine priрубnice slivnika na nivo FPO odnosno TPO-hidroizolacije	Za produljenje završnog okvira
 <p>HL85N + HL83.P</p>	 <p>HL85N + HL83.PP</p>	 <p>HL340N</p>
 <p>HL8500 + HL8300.P</p>	 <p>HL8500 + HL8300.PP</p>	 <p>HL3400</p>
 <p>HL350.0</p>	 <p>HL350.0</p>	 <p>HL350</p>
 <p>HL618 + HL86.0</p>	 <p>HL618 + HL86.0</p>	 <p>HL620</p>
 <p>HL65P</p>	 <p>HL65F (HL65PE)</p>	 <p>HL350</p>
<p>-</p>	<p>-</p>	 <p>HL320</p>

# HL Hidroizolacijske garniture – Proizvodi – Podaci

## HL83.0, HL8300.0, HL84.0, HL86.0 Garnitura bez folije

### Podaci

Materijal	INOX V2A
Dimenzija	<b>HL83.0:</b> Ø 196 x 114 mm <b>HL8300.0:</b> Ø 238 x 148 mm <b>HL84.0:</b> Ø 220 x 155 mm <b>HL86.0:</b> Ø 278 x 198 mm
Preporučeno za	stezno spajanje krovne izolacije sa priрубnicom slivnika
Odgovara za	<b>HL83.0:</b> HL70, HL80, HL90, HL92, HL300, HL304, HL310-serija, HL510-serija i nastavni element HL85N <b>HL8300.0:</b> HL3100(Pr) i HL5100(Pr) kao i za nastavni element HL8500 <b>HL84.0:</b> HL72.1 i HL317 <b>HL86.0:</b> HL615 i HL616 kao i za nastavni element HL618

### HL83.0

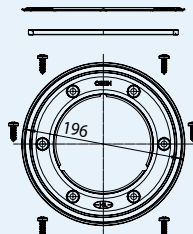

### HL8300.0

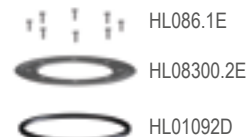
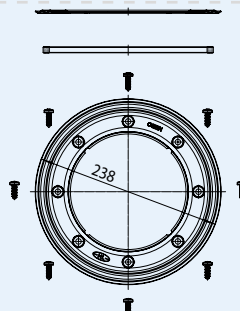

### HL84.0

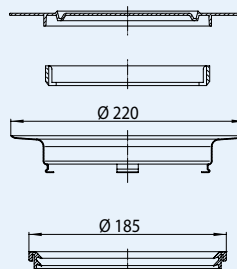

### HL86.0

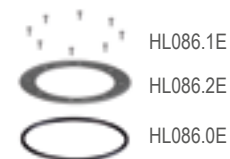
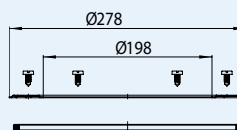

HL-br.	Težina	EAN	Kom./Pak.
83.0	245 g	+718306	1
8300.0	303 g	+025497	1
84.0	395 g	+718405	1
86.0	340 g	+711864	1

## HL83.M, HL8300.M, HL84.M, HL86.M Brtveća garnitura sa inox prirubnicom i folijom (laminirana vlaknima)

### Podaci

Materijal	INOX V2A/ Folija (laminirana vlaknima)
Dimenzija	<b>HL83.M:</b> Prirubnica Ø 196 x 114 mm Folija (laminirana vlaknima) 400 x 500 mm <b>HL8300.M:</b> Prirubnica Ø 238 x 148 mm Folija (laminirana vlaknima) 500 x 500 mm <b>HL84.M:</b> Prirubnica Ø 220 x 155 mm Folija (laminirana vlaknima) 500 x 500 mm <b>HL86.M:</b> Prirubnica Ø 278 x 198 mm Folija (laminirana vlaknima) 500 x 500 mm
Preporučeno za	Za alternativne hidroizolacije povezane sa keramičkim pločicama kao na primjer epoksidni, jedno ili dvokomponentni fleksij-premazi
Odgovara za	<b>HL83.M:</b> HL70, HL80, HL90, HL92, HL300, HL304, HL310-serija, HL510-serija i nastavni element HL85N <b>HL8300.M:</b> HL3100(Pr) kao i za nastavni element HL8500 <b>HL84.M:</b> HL72.1 i HL317 <b>HL86.M:</b> HL615 i HL616 kao i za nastavni element HL618

### HL83.M

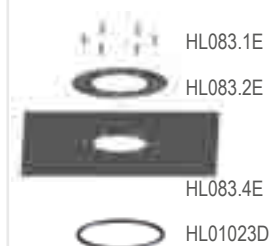
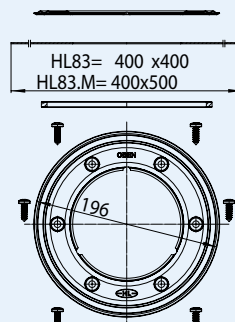

### HL8300.M

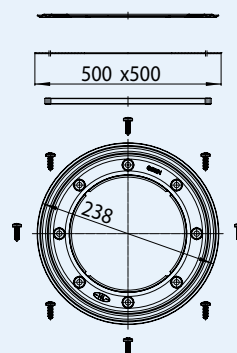

### HL84.M

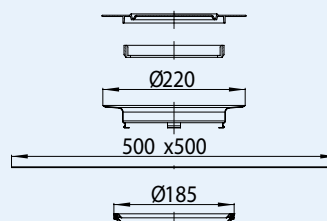

### HL86.M

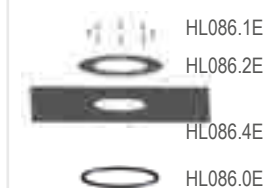
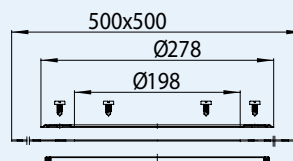

HL-br.	Težina	EAN	Kom./Pak.
83.M	425 g	+030835	1
83.3020	425 g	+034307	1
8300.M	425 g	+025473	1
84.M	730 g	+030842	1
86.M	590 g	+713868	1

**HL83, HL8300, HL84, HL86 Hidroizolacijska garnitura sa EPDM-folijom**
**Podaci**

Materijal	INOX V2A/ EPDM-folija
Dimenzija	<b>HL83:</b> Prirubnica Ø 196 x 114 mm EPDM-folija 400 x 400 mm <b>HL8300:</b> Prirubnica Ø 238 x 148 mm, EPDM-folija 500 x 500 mm <b>HL84:</b> Prirubnica Ø 220 x 155 mm, EPDM-folija 500 x 500 mm <b>HL86:</b> Prirubnica Ø 278 x 198 mm EPDM-folija 500 x 500 mm
Preporučeno za	Za EPDM-trake, bitumenske premaze i za ljepljenje sa bitumenskim trakama
Odgovara za	<b>HL83:</b> HL70, HL80, HL90, HL92, HL300, HL304, HL310-serija, HL510-serija i nastavni element HL85N <b>HL8300:</b> HL3100(Pr) i HL5100(Pr) kao i za Nastavni element HL8500 <b>HL84:</b> HL72.1 i HL317 <b>HL86:</b> HL615 i HL616 kao i za nastavni element HL618

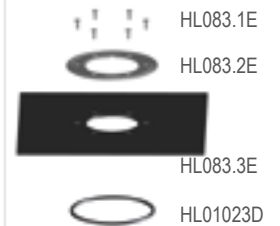
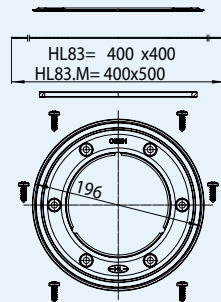
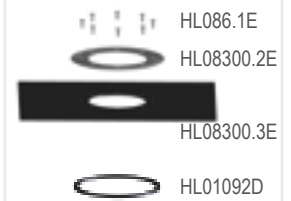
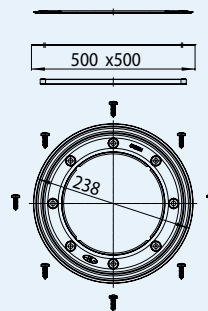
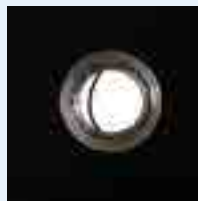
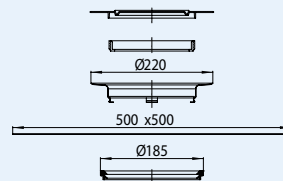
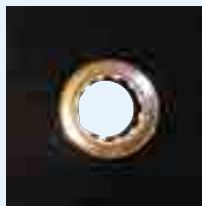
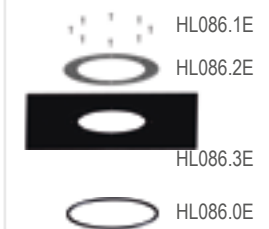
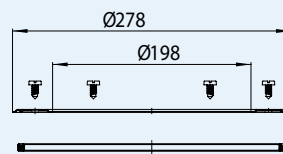
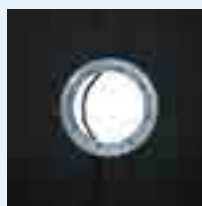
**HL83**

**HL8300**

**HL84**

**HL86**

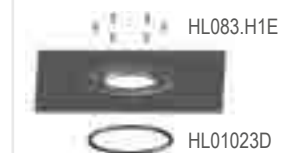
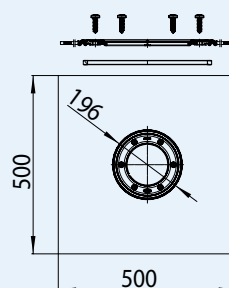
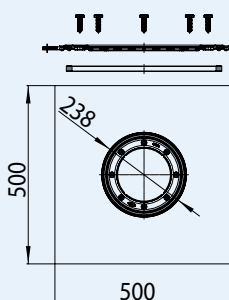
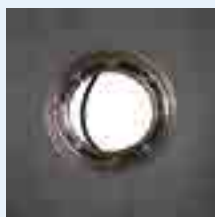
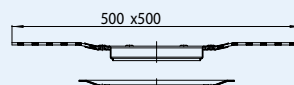
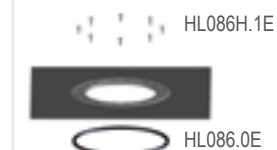
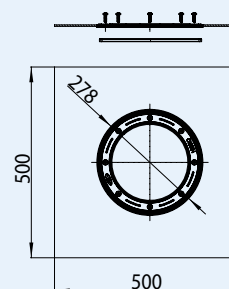
HL-br.	Težina	EAN	Kom./Pak.
83	425 g	+710836	1
8300	601 g	+025466	1
84	730 g	+710843	1
86	590 g	+710867	1

**HL83.H, HL8300.H, HL84.H, HL86.H Hidroizolacijska garnitura sa bitumenskom trakom**
**Podaci**

Materijal	INOX V2A / Bitumen
Dimenzija	<b>HL83.H:</b> Prirubnica Ø 196 x 114 mm, Bitumenska manžeta 500 x 500 mm <b>HL8300.H:</b> Prirubnica Ø 238 x 148 mm, Bitumenska manžeta 500 x 500 mm <b>HL84.H:</b> Prirubnica Ø 220 x 155 mm, Bitumenska manžeta 500 x 500 mm <b>HL86.H:</b> Prirubnica Ø 278 x 198 mm, Bitumenska manžeta 500 x 500 mm
Preporučeno za	<b>zavarivanje sa bitumenskim trakama</b>
Odgovara za	<b>HL83.H:</b> HL70, HL80, HL90, HL92, HL300, HL304, HL310- serija, HL510-serija i nastavni element HL85N <b>HL8300.H:</b> HL3100(Pr) i HL5100(Pr) kao i za nastavni element HL8500 <b>HL84.H:</b> Modeli krovnih slivnika: HL62, HL64, HL63, Nastavni element: HL65 <b>HL86.H:</b> HL615 i HL616 kao i za nastavni element HL618

**HL83.H**

**HL8300.H**

**HL84.H**

**HL86.H**

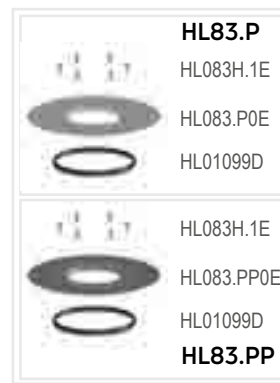
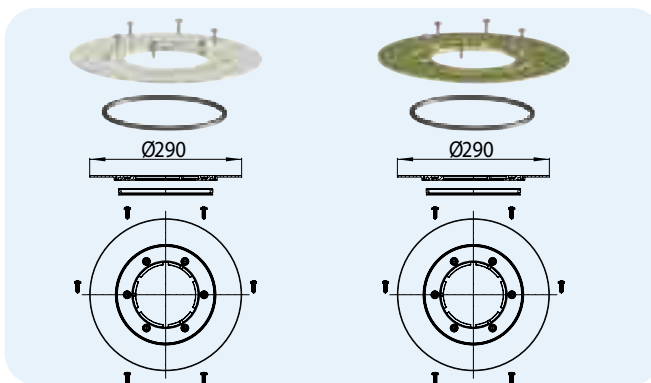
HL-br.	Težina	EAN	Kom./Pak.
83.H	1560 g	+008315	1
8300.H	1560 g	+025480	1
84.H	1707 g	+011841	1
86.H	1590 g	+008612	1

**HL83.P, HL83.PP Hidroizolacijska garnitura sa PVC odnosno PP prirubnicom**
**Podaci**

Materijal	<b>HL83.P:</b> PVC <b>HL83.PP:</b> PP (Polipropilen)
Dimenzija	<b>HL83.P:</b> Prirubnica Ø 290 mm <b>HL83.PP:</b> Prirubnica Ø 290 mm
Preporučeno za	<b>HL83.P:</b> PVC-Hidroizolacije <b>HL83.PP:</b> FPO odnosno TPO Hidroizolacije na bazi PP (Polipropilen)
Odgovara za	HL70, HL80, HL90, HL92, HL300, HL304, HL310-serija, HL510- serija i nastavni element HL85N



HL-br. 83.P	Težina 425 g	EAN +010837	Kom./Pak. 1
83.PP	653 g	+028641	1

**HL8300.P, HL8300.PP Hidroizolacijska garnitura sa PVC odnosno PP prirubnicom**
**Podaci**

Materijal	<b>HL8300.P:</b> PVC <b>HL8300.PP:</b> PP (Polipropilen)
Dimenzija	<b>HL8300.P:</b> Prirubnica Ø 350 mm <b>HL8300.PP:</b> Prirubnica Ø 350 mm
Preporučeno za	<b>HL8300.P:</b> PVC-Hidroizolacije <b>HL8300.PP:</b> FPO odnosno TPO Hidroizolacije na bazi PP (Polipropilena)
Odgovara za	seriju slivnika HL3100 i HL5100 kao i za nastavni element HL8500

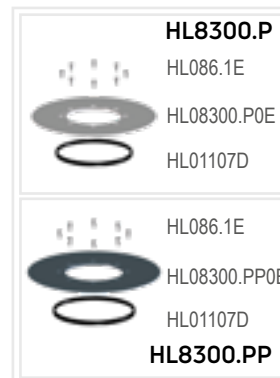
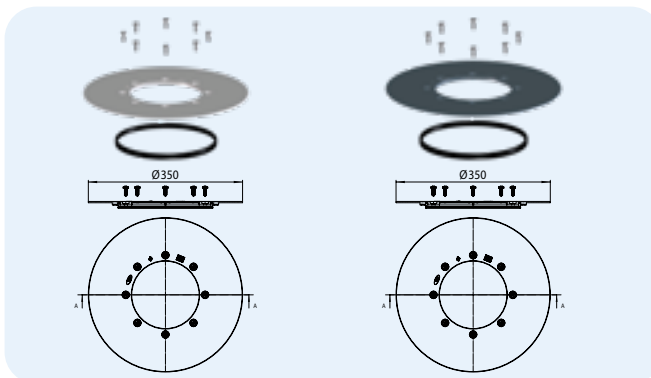

HL-br. 8300.P	Težina 530 g	EAN +034741	Kom./Pak. 1
8300.PP	320 g	+034758	1

**HL84.CU, HL84.E Hidroizolacijska garnitura sa bakrenim odnosno pocinčanim limom**
**Podaci**

Materijal	<b>HL84.CU:</b> Bakreni lim <b>HL84.E:</b> Pocinčani lim
Dimenzija	<b>HL84.CU:</b> 500 x 500 mm <b>HL84.E:</b> 500 x 500 mm
Preporučeno za	<b>HL84.CU:</b> za krovove pokrivene bakrenim limom <b>HL84.E:</b> za krovove pokrivene pocinčanim limom
Odgovara za	Serija krovnih slivnika HL62, HL63, HL64, HL65 i HL69

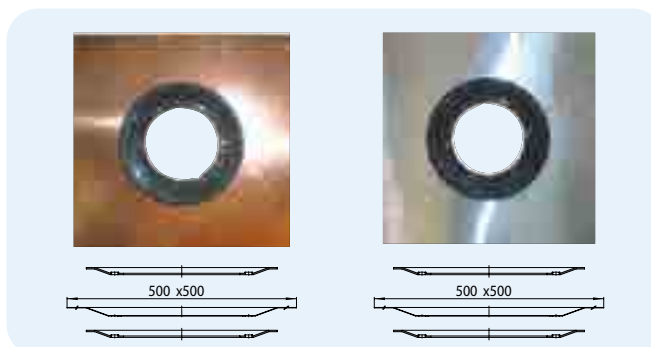

HL-br. 84.CU	Težina 1835 g	EAN +444847	Kom./Pak. 1
84.E	1830 g	+111848	1

**HL84.L Flis laminirana folija s TPE steznom površinom za tekuću krovnu hidroizolaciju**
**Podaci**

Materijal	TPE, brtvena folija laminirana flisom
Dimenzija	500 x 500 mm
Preporučeno za	<b>Tekuću hidroizolaciju bez otapala</b>
Odgovara za	HL62, HL64, HL65 sa steznom prirubnicom

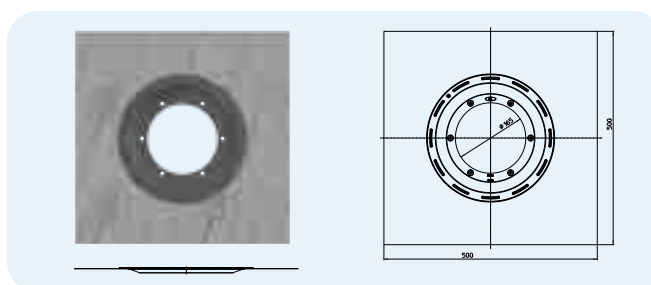

HL-br. 84.L	Težina 730 g	EAN +000739	Kom./Pak. 1
----------------	-----------------	----------------	----------------

# HL Nastavni elementi – Proizvodi – Podaci

## HL320, HL340N, HL3400, HL350, HL620 produljenje

### Podaci

Materijal	PP (Polipropilen)
Dimenzija	<b>HL320:</b> Ø 90 mm, h: 35 mm <b>HL340N:</b> Ø 110 mm, h: 100 mm <b>HL3400:</b> Ø 146 mm, h: 200 mm <b>HL350:</b> Ø 145 mm, h: 130 mm <b>HL620:</b> Ø 195 mm, h: 100 mm
Preporučeno za	Za podešavanje visine završnog okvira
Odgovara za	<b>HL320:</b> HL92 <b>HL340N:</b> HL70, HL80, HL90, HL300, HL304, HL310-serija, HL510-serija i nastavni element HL85N <b>HL3400:</b> za seriju HL3100 i 5100 <b>HL350:</b> HL72.1, HL317, HL62, HL63, HL64, HL65, HL69 <b>HL620:</b> HL615 i HL616

### HL320

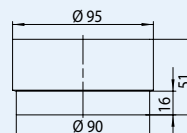

### HL340N

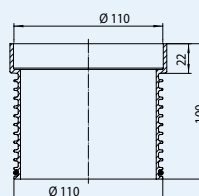

### HL3400

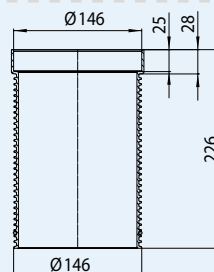

### HL350

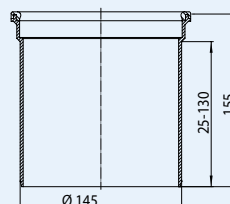

### HL620

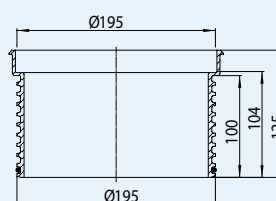

HL01067D



HL01093D



HL01056D

HL-br.	Težina	EAN	Kom./Pak.
340N	75 g	+003402	1
3400	117 g	+025565	1
350	240 g	+703500	1
620	270 g	+014255	1

**HL85N, HL8500, HL350.1, HL350.0, HL618, HL65** Nastavni element sa prirubnicom

**Podaci**

Materijal	PP (Polipropilen)
Dimenzija	<b>HL85N:</b> Ø 110 x 220 mm, h: 204 mm <b>HL8500:</b> Ø 146 x 239 mm, h: 202 mm <b>HL350.1:</b> Ø 145 x 300 mm, h: 180 mm <b>HL618:</b> Ø 195 x 315 mm, h: 95 mm <b>HL65:</b> Ø 125 x 354 mm, h: 260 mm
Preporučeno za	Za podešavanje visine prirubnice slivnika na nivo hidroizolacije
Odgovara za	<b>HL85N:</b> HL70, HL80, HL90, HL300, HL304, HL310-serija, HL510-serija <b>HL8500:</b> HL3100(Pr) i HL5100(Pr) <b>HL350.1:</b> HL72.1, HL317, HL62, HL63, HL64, HL65 i HL69 <b>HL618:</b> HL615, HL616 <b>HL65:</b> HL62, HL64

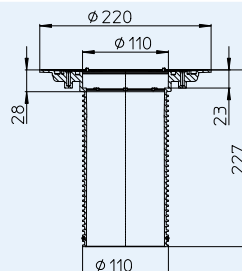
**HL85N**

HL01067D

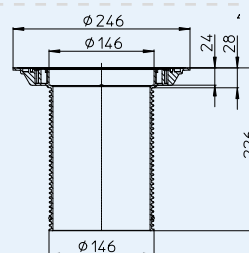
**HL8500**

HL03100.0E

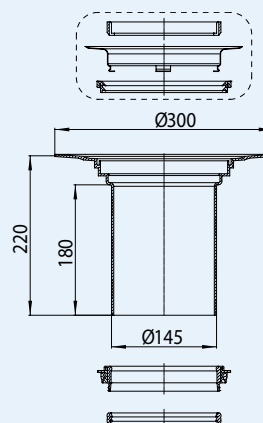

HL01093D

**HL350.1 (HL350.0)**

HL062B.3E



HL084.2E



HL084.3E

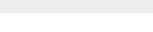
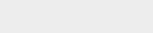
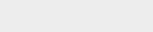
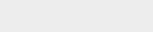
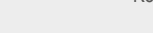
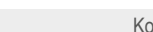
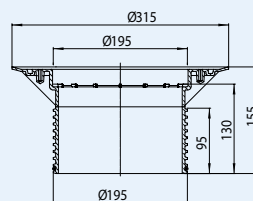

HL084.4E

**HL618**

HL01056D

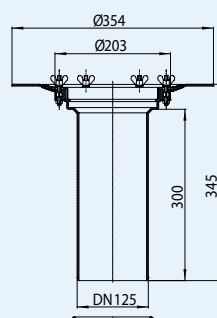
**HL65**

HL062.4E



HL170



HL062.3E



HL01020D

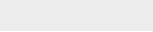
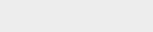
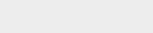
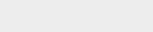
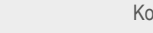
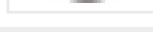

HL-br.	Težina	EAN	Kom./Pak.
85N	395 g	+006120	1
8500	320 g	+025572	1
350.0	680 g	+032358	1
350.1	1440 g	+703517	1
618	500 g	+013159	1
65	1440 g	+800650	1

**HL85NH, HL8500H, HL350.1H, HL618H, HL65H** Nastavni element sa tvornički povezanom bitumenskom trakom i slivnikom

**Podaci**

Materijal	PP / INOX / Bitumen
Dimenzija	<b>HL85NH:</b> Ø 110 mm, h: 204 mm, Bitumenska prirubnica: Ø 420 mm <b>HL8500H:</b> Ø 146, h: 202 mm, Bitumenska prirubnica: 500 x 500 mm <b>HL350.1H:</b> Ø 145, h: 180 mm, Bitumenska prirubnica: Ø 500 mm <b>HL618H:</b> Ø 195 mm, h: 95 mm, Bitumenska prirubnica: 500 x 500 mm <b>HL65H:</b> Ø 125 mm, h: 260 mm, Bitumenska prirubnica: Ø 500 mm
Preporučeno za	bitumenske trake
Odgovara za	<b>HL85NH:</b> HL70, HL80, HL90, HL300, HL304, HL310-serija, HL510-serija <b>HL350.1H:</b> HL72.1, HL317, HL62, HL63, HL64, HL65, HL69 <b>HL618H:</b> HL615 i HL616 <b>HL65H:</b> HL62, HL64

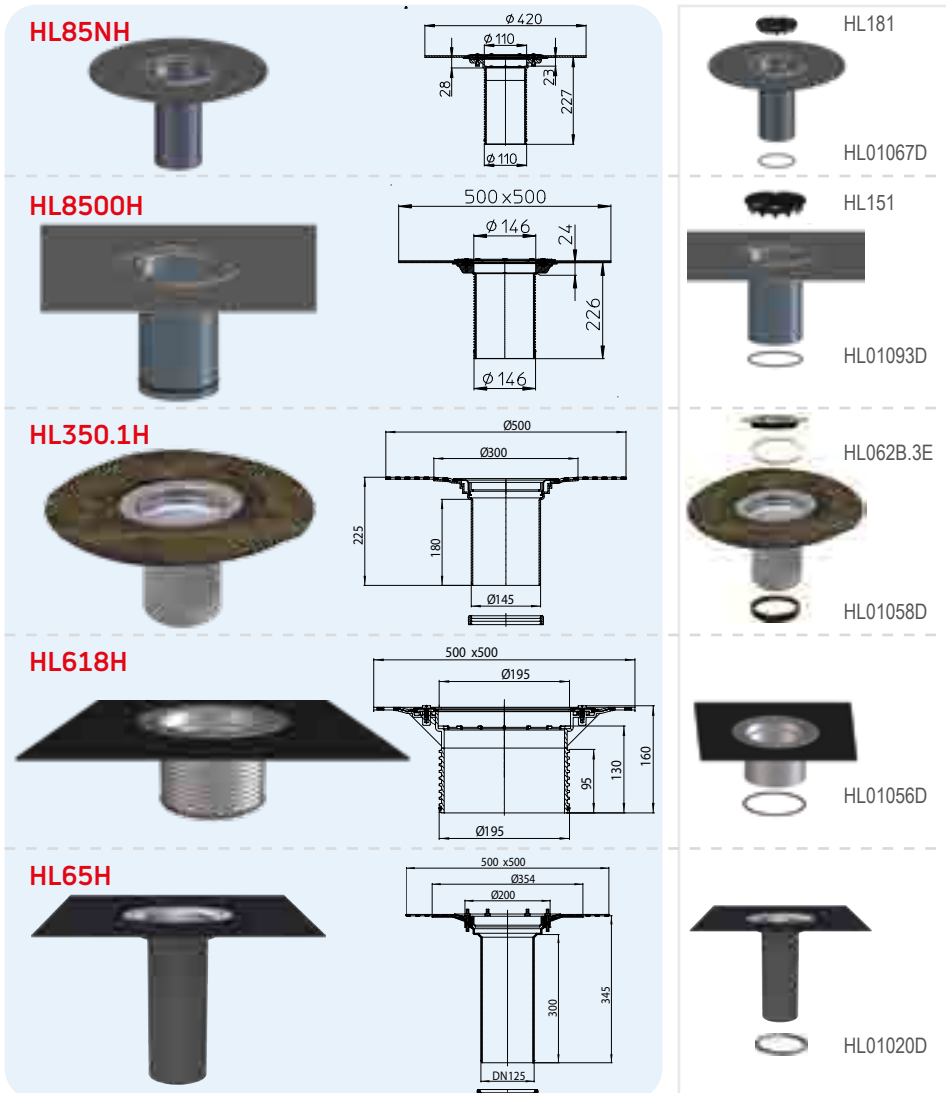

HL-br.	Težina	EAN	Kom./Pak.
85NH	980 g	+009015	1
8500H	2346 g	+034765	1
350.1H	1550 g	+001842	1
618H	1750 g	+013173	1
65H	2140 g	+801657	1

**HL65P, HL65F, HL65PE** Nastavni element

**Podaci**

Materijal	<b>HL65P:</b> PVC <b>HL65F:</b> PP <b>HL65PE:</b> PE
Dimenzija	<b>HL65P:</b> Ø 125 mm, h: 350 mm, Prirubnica: Ø 354 mm <b>HL65F, HL65PE:</b> Ø 125 mm, h: 345 mm, Prirubnica: Ø 355 mm
Preporučeno za	<b>HL65P:</b> PVC-hidroizolacije <b>HL65F:</b> FPO odnosno TPO-hidroizolacije na bazi PP (Polipropilena) <b>HL65PE:</b> FPO-izolacije na bazi PE (Polietilena)
Odgovara za	seriju krovnih slivnika HL62 i HL64

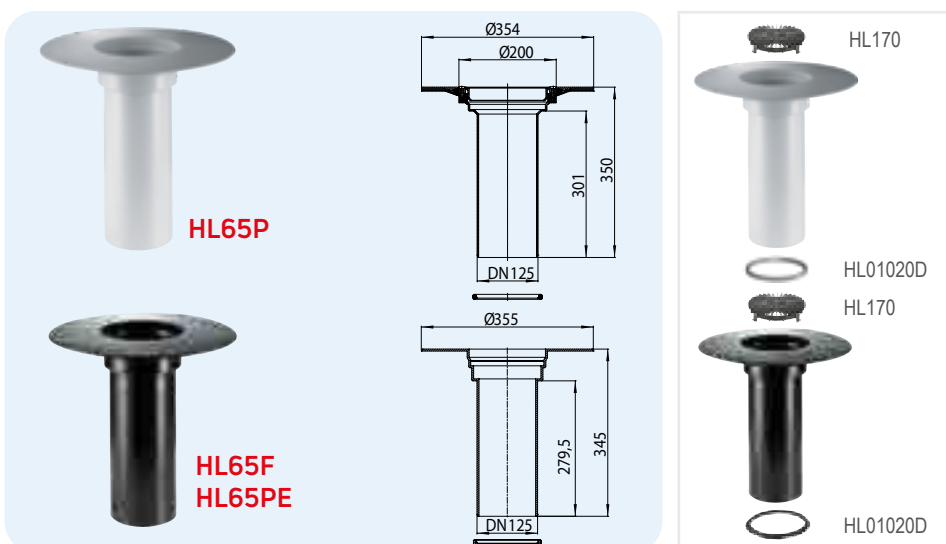

HL-br.	Težina	EAN	Kom./Pak.
65P	1370 g	+022588	1
65F	830 g	+031900	1
65PE	850 g	+035915	1



SIPHONS ABLÄUFE